

Danish Energy Research Programme (EFP)

Energy Performance Contracting

– energy saving potential of selected energy conservation measures (ECM)

September 2008

CENERGIA



DONG
energy



DANSK ENERGI ANALYSE A/S

Danish Energy Research Programme (EFP)

Energy Performance Contracting – energy saving potential of selected energy conservation measures (ECM)

September 2008

Authors:

Mogens Johansson, Dansk Energi Analyse

Gunnar Langkilde, ICIEE, DTU

Ove Mørck, Cenergia Energy Consultants

Bjarne W. Olesen, ICIEE, DTU

Ole Sundman, DONG Energy

Kirsten Engelund Thomsen, SBi, AAU

Preface - english

This report has been developed under the research project "Etablering af grundlag for energitjenester i Danmark" (project number: ENS-33031-0185) under the Danish research programme – EFP.

The objective of this project has been to contribute to the utilisation of the large potential for energy conservations in the building sector within the public, industry and service sectors through the development of a better basis for decision making for both the Energy Service Companies (ESCO-es) and the building owners. The EU directive on Energy Service Contracting points at the buildings as the area where the biggest potential market for energy services and energy efficiency improvements are.

The EFP-project has two parts: (1) A Danish part and (2) participation in the international cooperation project "Holistic Assessment Tool-Kit on Energy Efficient Retrofit Measures for Government Buildings (EnERGo)", Annex 46 under the IEA R&D program "Energy Conservation In Buildings And Community Systems" (ECBCS). This report describes the Danish contributions to the IEA projects subtask B, which has a primary objective to develop a database of energy conservation measures (ECM) with descriptions and performance characteristics of these.

In addition to this report the project has issued the reports "Energitjenester – Statusredegørelse og eksempler" (October 2007) and " Energitjenester – indledende analyser og kontrakter" (August 2008).

Forord

Denne rapport er udarbejdet i forbindelse med EFP-projektet: "Etablering af grundlag for energitjenester i Danmark" (projektnummer: ENS-33031-0185).

Formålet med projektet har været at medvirke til at udnytte de store potentialer for energibesparelser i byggeriet indenfor det offentlige, i industrien og i servicesektoren gennem tilvejebringelse af et bedre beslutningsgrundlag for udbydere af energitjenester (energitjenesteselskaber) og ikke mindst for bygningsejerne. EU's energitjenestedirektiv peger på bygningerne som det sted, hvor det største uudnyttede marked for energitjenester og energieffektivisering findes.

Ovennævnte EFP-projekt er udformet således at det har en selvstændig dansk del og desuden deltagelse i det internationale samarbejdsprojekt "Holistic Assessment Tool-Kit on Energy Efficient Retrofit Measures for Government Buildings (EnERGo)", Annex 46 under IEA F&U programmet "Energy Conservation In Buildings And Community Systems" (ECBCS). Denne rapport beskriver de danske bidrag til det internationale projekts subtask B, der har som primært mål at udarbejde en database over energibesparende tiltag med beskrivelser og ydelseskarakteristikker for disse.

Ud over indeværende rapport har projektet i oktober 2007 udsendt rapporten "Energitjenester – Statusredegørelse og eksempler" og i juli 2008 rapporten " Energitjenester – indledende analyser og kontrakter".

Septembert 2008

Ove Mørck

Cenergia Energy Consultants.

List of content

1	Introduction – IEA ECBCS Annex 46	5
1.1	Subtask B – results presented in this report	7
2	Performance of energy conservation measures (ECM) - energy simulations	8
2.1	Introduction	8
2.2	Thermal activated building system	11
2.3	Control of the system	12
2.4	Results and discussion.....	13
2.5	Conclusions	19
2.6	Temperature profile plots	20
3	Description of selected ECMs	23
3.1	Solar wall for outdoor air preheating	23
3.2	Radiant floor heating and cooling systems.	29
3.3	Embedded surface radiant heating and cooling systems.....	38
3.4	Radiant heating and cooling panels.....	44
3.5	Envelope Sealing Systems: Radiant Barrier, and Spray Foam Insulation	50
4	Referencer.....	56
5	Annexes	57
5.1	Template format for ECM descriptions	57
5.2	Case study format.....	58

1 Introduction – IEA ECBCS Annex 46

Annex 46 is an international research cooperation project carried out under the umbrella of the IEA ECBCS programme. The ECBCS Mission Statement is: "To facilitate and accelerate the introduction of energy conservation and environmentally sustainable technologies into healthy buildings and community systems, through innovation and research in decision-making, building products and systems, and commercialization". Currently 51 projects is ongoing or have been completed under the ECBCS programme.

The scope of the Annex 46 “Holistic Assesment Tool-Kit on Energy Efficient Retrofit Measures for Government Buildings (EnERGo)” is the decision making process for energy retrofitting of government/public non-residential buildings: e.g., office/administrative buildings, dormitories/barracks, service buildings and production and maintenance facilities.

The Annex is meant to influence the decision making process that determines the use of energy-saving measures in building retrofits. This decision making process must improve if it is to successfully cope with the challenges of increasing energy costs and climate change, and if it is to avoid "locking in" long-term commitment to energy inefficiencies by adopting sub-optimal renovations. Consequently, the target group consists of all actors involved in this decision making process, specifically executive decision makers and energy managers of Government buildings, performance contractors and designers. The IT-tool-kit EnERGo, supplemented by guidelines and best practice examples, will support these different user groups, and facilitate communication between them.

The objectives of this Annex are:

To provide tools and guidelines for decision makers and energy managers, performance contractors and designers to improve the working environment of Government buildings through energy-efficient retrofitting projects. Though the focus of this Annex is on Government buildings, many results can be applied to similar private sector buildings;

To provide recommendations on how to operate the retrofitted buildings;

To promote energy- and cost-efficient retrofit measures by providing successful examples;

To support decision makers in evaluating the efficiency and acceptance of available concepts;

To find improved ways of using Energy Performance Contracts (ESPC's) for Government buildings retrofit measures.

To accomplish these objectives, participants will carry out research and development in the framework of the following four Subtasks (A, B, C and D):

Subtask A: Develop an energy assessment and analysis methodology/protocol and the "Energy Assessment Guide for Energy Managers and ESCOs"

Subtask A will analyse best practices and procedures of identifying energy conservation opportunities in retrofitted Government and Public buildings. The opportunities relate to the building envelop, lighting, internal loads, HVAC, and other mechanical and energy systems. Subtask A will develop a common protocol for conducting energy assessments at administrative/office buildings, barracks and dormitories, service buildings, production and

maintenance facilities. It will document resource consuming activities, and identify wasteful practices, prioritize conservation opportunities, implement best practices, and guide investment in resource-conserving technology upgrades. The Annex will address several different scope (building stock, individual building, system and component) and depth levels of assessment:

Energy conservation opportunities analysis. This involves no instrumentation using basic analysis to generate a list of top energy saving ideas (Level 1).

Energy optimization analysis geared toward funds appropriation. This calculates savings and uses partial instrumentation with cursory analysis (Level 2).

Detailed engineering analysis with implementation, M&V. This includes performance measurement and verification assessment, and a fully instrumented diagnostic audit (Level 3).

Subtask A will develop the rationale behind each of three levels of assessment. It will state the motivations behind undertaking each level, the expected results, and the degree of effort and instrumentation required. It will specify procedures, calculation tools and suggest the format of the report that will document the assessment findings. The subtask will result in the "Energy Assessment Guide for Energy Managers and ESCOs," which can be used in Energy Audits and serve as a basis for the Energy Service Performance Contracts. Pilot studies will be conducted to apply and test the guide.

Subtask B: Develop a database of "Energy Saving Technologies and Measures for Government Building Retrofits" with examples of best practices and case-studies.

Subtask B will analyze a series of completed and planned best practices of buildings retrofits with energy efficient technologies of which a few are still under renovation and are to be finished in 2006-2007. Based on these international experiences and best practices, Subtask B will develop a database with case studies of promising energy saving technologies and measures (current, proven, well known or underused). These will include technologies/measures that relate to building envelope, internal load reduction, lighting, HVAC systems, energy consuming processes in the building, supplemental energy systems (e.g., compressed air, steam system), etc.

Subtask B will identify tools/computer programs to screen selected candidate technologies/measures, develop a procedure for that and screen for representative conditions (building type, standard climatic conditions, energy costs, etc). The technology descriptions and the results of the screening analyses and the case studies will be summarized by categories and presented in a user-friendly format. The database of measures and technologies will be used in Subtask D.

Subtask C: Develop "Best-practice guidelines for innovative energy performance contracts".

Energy Performance Contracts (EPCs) are a method by which governments can finance energy conservation projects in their buildings using the energy and energy-related cost savings generated by the projects themselves. Numerous countries have put in place the mechanisms to permit EPCs in public and private buildings. The objective of this work is to identify and document the approaches countries have used to implement successful EPCs projects at government facilities in their countries, and to develop a set of consensus recommendations that can be used to improve existing EPCs programs, and implement new programs in countries that currently lack them. These

recommendations will be compiled in a Best Practices Guide for Innovative Energy Performance Contracts. This guide will be translated as necessary into other languages for use by participating countries.

A "Best-Practice Guidelines for Innovative Energy Performance Contracts" will be developed and will:

- Identify different goals and motivating factors for the use of EPCs.
- Describe reasoning by different countries for using EPCs in combination with or versus other funding mechanisms.
- Compile model EPCs contracts, documents, and processes. Analyze and compare these to identify best practices and their applicability in different country environments.
- Compare technical/engineering practices in the areas of baseline development, estimation of energy and cost savings, risks and guarantees, and measurement and verification of savings. Identify those techniques that have been most successful in allowing countries to meet their goals.

Subtask D: "IT-Toolkit "EnERGo"

Subtasks A, B, and C will provide their results as input to this joint activity. Subtask D will be based on these results, and will develop an electronic interactive source book (IT-Toolkit "EnERGo"). A central database will include all Annex results and will allow users to obtain extensive information, according to their individual focus of interest: energy saving opportunities, design inspirations, design advice, decision tools, design tools, commissioning methods, long-term monitoring systems and measures that require no financial investment. Thus, users will be able to quickly and reliably increase their knowledge in specific fields of interest. They may choose between analyzing design scenarios individually, or they may access a broader pool of information on energy saving potentials and requirements by using experiences gained from "best practice" examples.

1.1 Subtask B – results presented in this report

Denmark participates in all 4 of these subtasks, but with strongest emphasis on subtask B, for which Denmark (represented by Ove Moerck, Cenergia Energy Consultants) is the subtask leader. This report refers to the work carried out in Denmark for subtask B during the first two years of the 4 year project. The other activities carried out in Denmark in relation to this Annex and the Danish national activities defined in parallel is documented in 2 other reports (in Danish) from the EFP-projekt: "Etablering af grundlag for energitjenester i Danmark" and "Energitjenester – indledende analyser og kontrakter" (all three reports under the project number:ENS-33031-0185).

The two main results of Subtask B are: (1) database of "Energy Saving Technologies and Measures and (2) case study descriptions. The database is constituted of a combination of description of energy conservation measures (ECM) and their technical and economical performance in various climates. This work has not been completed after the first 2 years of work within the IEA project, but the Danish participants have (a) developed a format for the description of the ECMs (see Annex 1), (b) described a number of ECMs presented in chapter 3 and (c) made computer simulations of selected ECMs – presented in chapter 2.

For the case studies Denmark as subtask B leader has been responsible for the development of a template for describing case studies. The template is presented in Annex 2. No case studies have been described using the template at this stage of the project.

2 Performance of energy conservation measures (ECM) - energy simulations

2.1 Introduction

Energy simulations were carried out for the following 3 ECMs:

- *Hydronic radiant floor heating and cooling*
- *Hydronic radiant ceiling panel heating and cooling*
- *Thermal activated building system (TABS)*

Note: All the simulations were done for an office buildings in Denmark. Energy+ was used as the simulation tool. As reference system a full VAV air system was used.

The results show an overall yearly energy saving for heating and cooling of 12-25% compared to the reference system.

2.1.1 Objectives

The study was aimed to investigate the potential and the capability of different hydronic radiant systems installed in an office building and the achieved performance in comparison with conventional full-air systems. The analysis was mainly focused on the energy issue and on the provided indoor comfort conditions. The project was also meant to understand in which extent Energy Plus is suitable for investigating radiant systems with flexible control and to develop several algorithms for the operation mode.

2.1.2 Model

The model adopted for the analysis was kept as much as possible unaltered from the original specification and the original construction details. Limited changes were applied in order to be able to better implement the radiant system in the zones.

The model was located in Copenhagen at latitude 55.37 with a longitude of 12.40. The year used in the simulation was 2007. Climate data file was: DNK Copenhagen IWEC 061800. Average hourly statistics are displayed in the table 1.

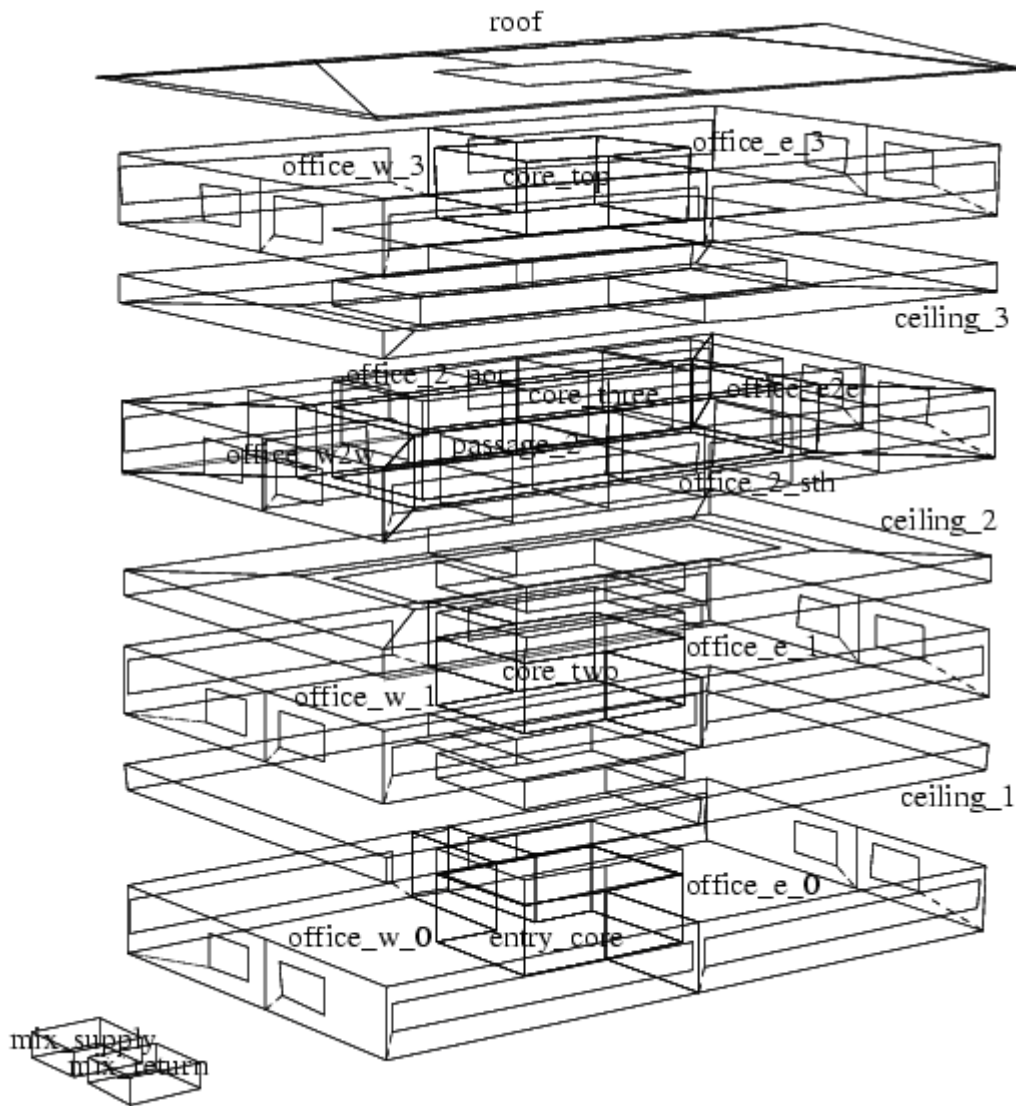

Figure 1 - office model for IEA Annex 46, from specification

Table 1 - Average hourly statistics outside dry bulb temperature [°C] from weather data

	Jan	Feb	Mar	Apr	May	Jun	Jul	Aug	Sep	Oct	Nov	Dec
0-1	1.1	-1.1	1.9	4.2	8.7	11.7	13.8	14.1	10.7	8.8	4.8	1
1-2	1.2	-1.1	1.8	4.1	8.6	11.4	13.6	13.9	10.6	8.8	4.8	0.9
2-3	1.4	-1.1	1.7	4	8.5	11.1	13.4	13.7	10.5	8.7	4.7	0.9
3-4	1.5	-1.1	1.5	3.9	8.3	10.9	13.2	13.6	10.4	8.7	4.6	0.9
4-5	1.5	-0.8	1.6	4.3	9.1	12	14.1	14.4	10.7	8.6	4.5	1
5-6	1.4	-0.6	1.7	4.6	9.9	13	15	15.3	11	8.6	4.5	1
6-7	1.4	-0.3	1.8	4.9	10.7	14.1	15.9	16.2	11.3	8.7	4.5	1.1
7-8	1.4	0	2.4	5.7	11.5	14.9	16.7	17.2	12	9.3	4.7	1.3
8-9	1.4	0.4	3	6.4	12.3	15.7	17.5	18.1	12.7	10	5	1.5
9-10	1.4	0.7	3.6	7.2	13.2	16.4	18.3	19.1	13.4	10.6	5.4	1.7
10-11	1.6	1.2	4	7.8	13.5	16.8	18.6	19.4	13.8	11	5.6	2
11-12	1.8	1.7	4.4	8.3	13.8	17.1	18.9	19.7	14.2	11.3	5.9	2.4
12-13	2	2.2	4.8	8.9	14.1	17.5	19.2	20	14.6	11.7	6.3	2.7
13-14	1.9	2	4.7	8.8	14.1	17.5	19.3	19.8	14.5	11.4	6.1	2.5
14-15	1.8	1.8	4.6	8.7	14.1	17.4	19.4	19.5	14.5	11.1	6	2.3
15-16	1.7	1.6	4.5	8.6	14.1	17.4	19.4	19.4	14.4	10.8	5.8	2.1
16-17	1.6	1.1	4	8.1	13.6	17	18.9	18.8	13.8	10.3	5.5	2

17-18	1.6	0.6	3.5	7.5	13.2	16.5	18.4	18.3	13.1	9.8	5.2	1.9
18-19	1.5	0.1	3	7	12.6	16.1	17.9	17.9	12.5	9.3	4.9	1.7
19-20	1.4	-0.1	2.9	6.4	11.7	15.1	16.9	17.1	12.1	9.2	4.9	1.7
20-21	1.3	-0.4	2.7	5.8	10.8	14.2	15.9	16.3	11.6	9.1	4.8	1.6
21-22	1.3	-0.6	2.5	5.2	9.8	13.3	15	15.5	11.2	9	4.8	1.5
22-23	1.2	-0.7	2.3	4.9	9.5	12.8	14.6	15	11	8.9	4.8	1.4
23-24	1.1	-0.9	2.1	4.5	9.2	12.2	14.3	14.5	10.7	8.8	4.7	1.3

Composition of the office zones was not altered and no environmental control was applied to the dropped ceilings as well to the roof zone. Active radiant surfaces were modeled as connected to the ceiling of the lower zone and the floor of the upper zone, without considering in the balance calculation the dropped ceilings. Thereby heat transfer from the pipes to the structure involved both the adjoining stores.

Calculation of the COP for the estimating the delivered energy demand was carried out by mean of a program tool which could give coefficient of performance hour by hour according to the water temperatures and the outside temperatures, simulating chiller and air to water heat pump.

2.1.3 Reference case

Full air system with VAV was chosen as base case. Airflow rate was adjusted to provide the required heating (or cooling); supply air temperatures were kept constant at 31°C in winter and 14°C in summer. Setpoint temperatures were set at 21°C for heating mode, 25.5°C for cooling mode and a dead band was assumed between these two values. Operative temperature could vary within that range during the day. In the night a setback was added as energy conservation measure with setpoint temperatures of 15°C and 30°C.

The reference case was meant to represent a basic example of a general full-air system, where no recirculation or recovery were taken into account, which could guarantee for most of the time with occupants, temperature profiles within the range of cat 1 of thermal comfort (as specified in standard EN ISO 7730:2005, EN 15251).

2.1.4 Radiant and ventilation systems

For all the cases two ventilation systems were considered, which guaranteed the fresh air required for indoor air quality. Flow rates were set as described in the specification (0.00944 m³/s/pers).

A mechanical ventilation system was first modeled, which supplied primary air at 17°C constant throughout the year. Even though no control on humidity was included, all the radiant systems could run properly, since supply temperature in the active surfaces didn't reach such remarkable low values capable of causing condensation problems.

Secondly natural ventilation system was analyzed. It was modeled as an air system with the same air flow rate as the previous case, with supply air temperature equal to the outside dry bulb temperature (with an inferior limit of 17°C to avoid cold draft).

Each radiant system was added to the model, coupling the air system. The ventilation system provided part of the base load by supplying the necessary primary air and guaranteeing indoor air quality. Radiant system covered instead the remaining and they were activated whenever comfort conditions were not met.

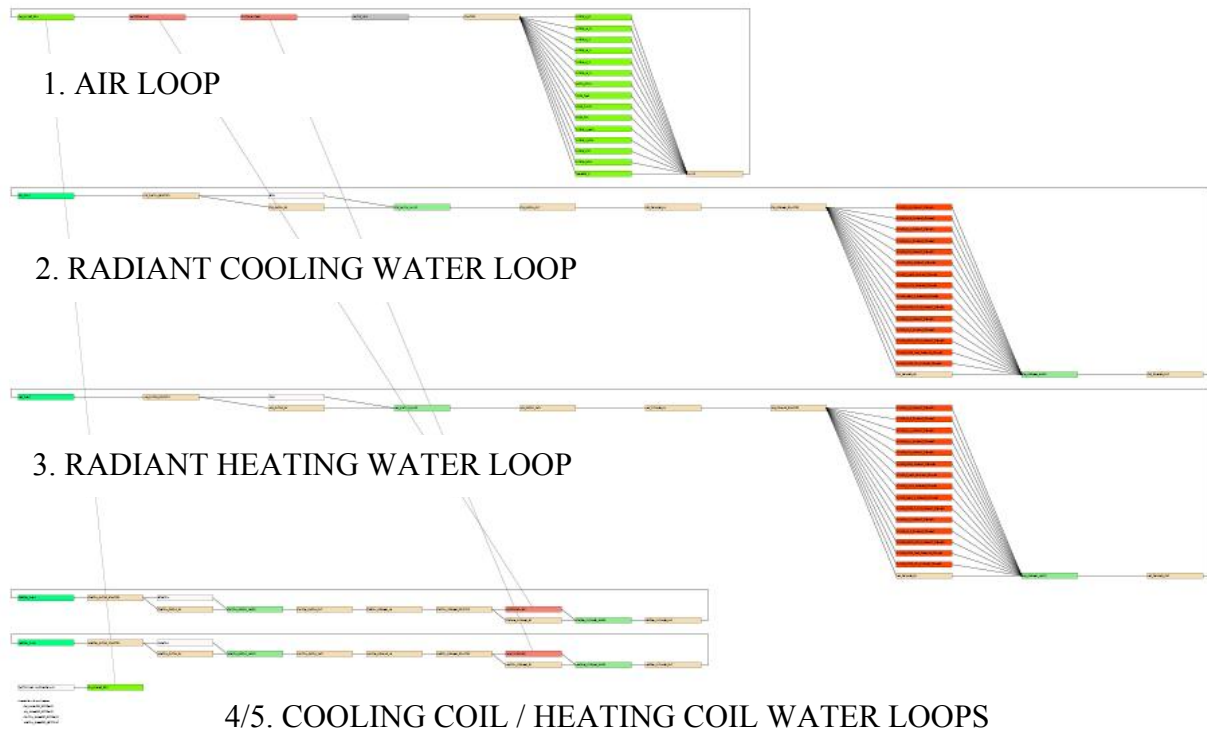

Figure 2 – Model of the HVAC as displayed in output by Energy Plus. Five loops were added: an air loop where the primary air was first treated by the coils and then supplied in all the zone (1), one loop which supplied cool water to the radiant system of every zone (2), one loop which supplied hot water to the radiant system of every zone (3), one loop to cool the water for the cooling coil of the air system (4), one loop to heat the water for the heating coil of the air system (5). Cooling and heating loads in loops 2/3/4/5 were provided by means of the features “purchased chilled/hot water”.

2.2 Thermal activated building system

The main characteristic of this system is the thermal conjugation of the emitted heating or cooling elements with the main building structure. Pipes are imbedded in the centre of the concrete slabs: due to the high thermal storage capacity of the building mass, the slabs can store or remove heat at different times in respect to the period of occupancy and it is not necessary to synchronize time of operation and thermal load. By means of high inertia of the structures peak load can be reduced and it is possible to transfer some loads to night-time operation.

Thermal slab system is considered a high temperature cooling and low temperature heating system: temperature of supplied water has a smaller difference from the indoor air than in traditional conditioning system. Higher efficiency is hence performed and using several different kinds of low-exergy sources is possible.

The active ceiling used in the model consisted of an 18 cm thick concrete slab with 20 mm plastic pipes embedded in the middle with 150 mm spacing. Above 20 mm of acoustical insulation and 45 mm of screed terminated the slab.

TABS were allowed to run during night time, when occupants were not present in the offices, for a period of time variable between 8 and 12 hours, depending on the case considered.

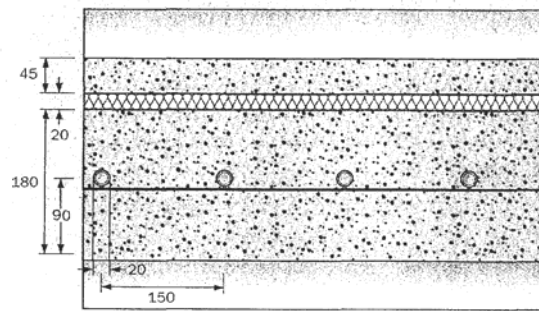

Figure 3- Thermal Activated Building system simulated in the analysis. Pipes were embedded in the middle of the concrete layer

2.2.1 Ceiling panel

Radiant panel (either suspended or inserted in the false ceiling) don't have a storage capacity as the thermal activated slabs; therefore their time operation had to be synchronized with the loads, coupling the ventilation system at the same time.

Panels were modeled on the ceiling of all the zones. They consisted of a MDF boards (Medium Density Fibreboard), an EPS (Expanded Polystyrene) panel, a shaped aluminium panel, PEX pipe 12 mm of inner diameter and 1.8 mm of thickness spaced 120 mm.

2.2.2 Heating and cooling floor

Radiant floor was used as the second radiant system for heating and cooling.

Pipes (17 mm diameter) were embedded in 45 mm of screed, with the same spacing of 150 mm. Below 30 mm of insulation and 150 mm of concrete were added.

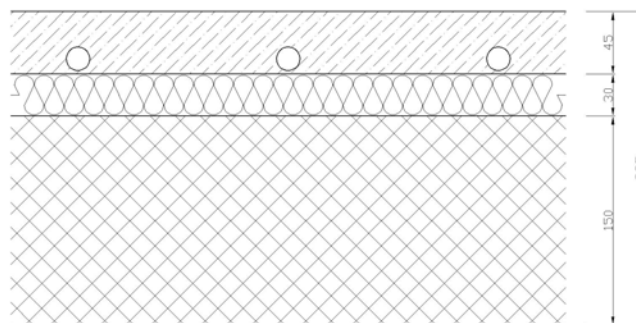

Figure 4 - Radiant heating and cooling floor. Pipes were spaced 150 mm

As ceiling panels, pipes in the floor were activated in concomitance with the occupants' presence.

2.3 Control of the system

All the radiative systems were investigated developing a type of control which could provide the best adaptation to the air system, enhancing at the same time the energy performance and the induced thermal comfort.

TABS, panel and floor acted differently with the internal environment, for instance due to their thermal inertia or the different view factor of the surfaces relating to the occupants position. Moreover the operating time varied depending on many factors. Thereby each system was analyzed separately and a specific control was developed for each construction.

The analysis was mainly focused on the appropriate control of the supply water temperature in the pipes. Previous studies analyzed different models for controlling this parameter:

Table 2 – Water supply temperature control previously studied

	$T_s = f1(Text, Top)$ $T_s = a \cdot (b - Text) + c \cdot (d - Top)$	$T_s = f3(Text)$ $T_s = e \cdot (f - Text)$	$T_s = f5(const)$
winter	$T_s = 65.6 - 0.52 \cdot Text - 1.6 \cdot Top$	$T_s = 26.1 - 0.45 \cdot Text$	25°C
summer		$T_s = 24.3 - 0.35 \cdot Text$	22°C

A specific analysis was carried out on these equations in order to improve the controls. The development was done by means of GenOpt program.

The optimization was focused on the thermal comfort and based on the concept that small deviations in the water temperature may affect substantially the heat transfer between surfaces and indoor environment. Due to the characteristic of the radiative exchange and to the inertia of the systems, keeping a steady state condition with constant temperature equal to the neutral one was not possible. Optimization was thereby aimed to minimize the distance of the temperature values from the neutral values and to create a temperature profile which was within the range of thermal comfort.

- 1st optimization: supply water temperature was based on hourly values of external dry bulb temperature and adjusted in each zone depending on the different operative temperatures (f2);
- 2nd optimization: supply water temperature was based on hourly values of external dry bulb temperature and it was assumed the same for all the office supplied (f4);
- 3rd optimization: supplied water temperature was constant value (f6).

Table 3 – Water supply temperature control obtained from optimization analysis by GenOpt

	$T_s = f2(Text, Top)$ $T_s = k \cdot (l - Text) + m \cdot (n - Top)$	$T_s = f4(Text)$ $T_s = p \cdot (q - Text)$	$T_s = f6(const)$
winter	$T_s = 65.5 - 0.4 \cdot Text - 1.75 \cdot Top$	$T_s = 27.1 - 0.4 \cdot Text$	28°C
summer		$T_s = 24.1 - 0.41 \cdot Text$	20°C

2.4 Results and discussion

The following cases display for each system the best compromise in terms of comfort conditions and energy performance.

1.1. Thermal comfort

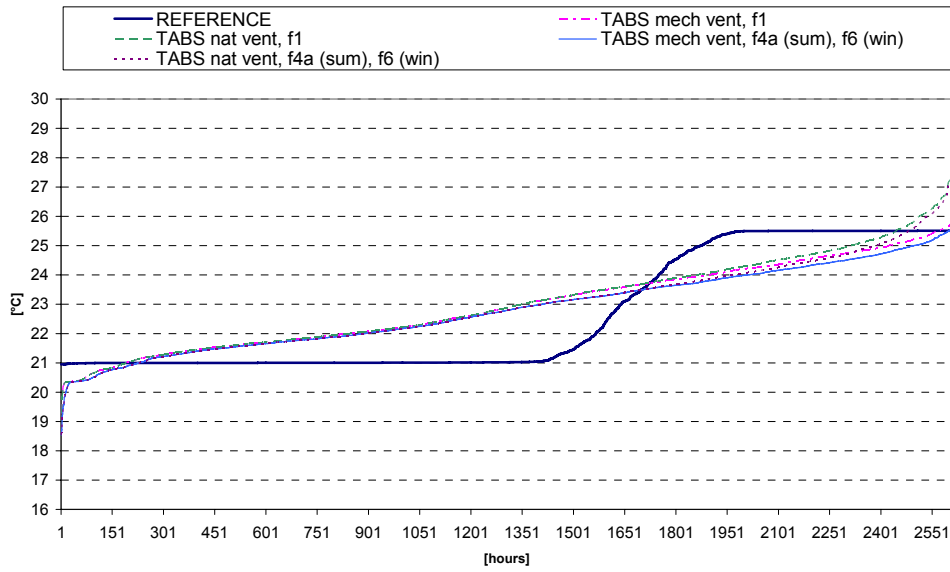

Figure 5 - Operative temperature frequency, reference case and TABS cases

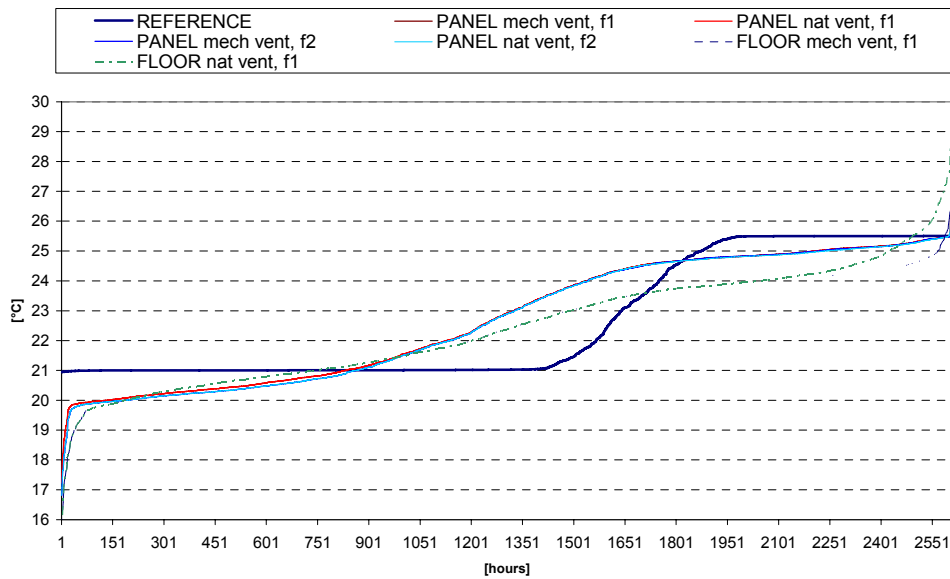

Figure 6 - Operative temperature frequency, reference case, ceiling panel and floor cases

Comfort conditions are indicated according to standard, in terms of percentage of time in which temperatures are within the range of cat A, B, C or exceed the boundaries. Winter and summer setpoints were set at 22 and 24.5 C. The definition of winter and summer period was based on the analysis of the weather data and the average duration of the heating and cooling for all the cases. Winter was assumed lasting from October to April, summer from May to September.

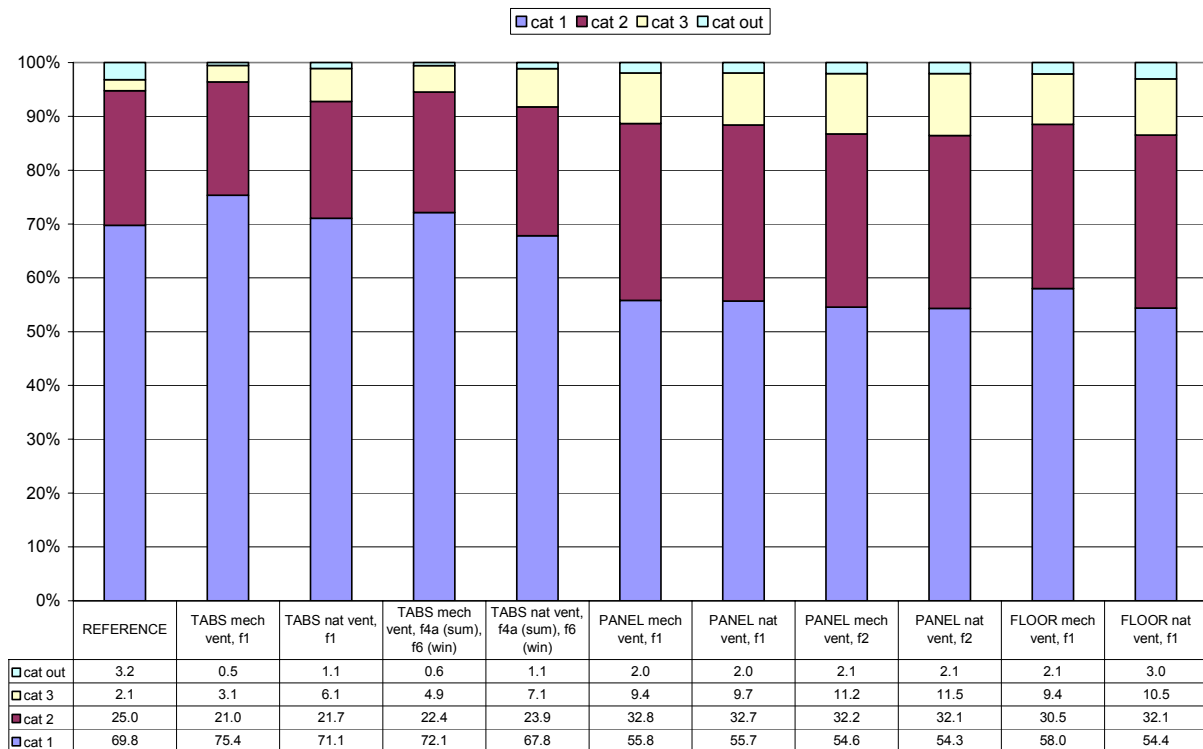

Figure 7 - categories of comfort achieved for the different systems

Despite of the VAV system which could provide heating and cooling load without any limitation, temperatures in the reference case exceeded for the 30% of the time category A and 5% category B of comfort. This was basically due to the use of the dead band, which allowed the temperature to float uncontrolled within the range.

TABS systems were able to ensure comfort condition with supply water control both on operative temperature or external temperature (category A and B were fulfilled for more than 90% of the time in all cases). External temperature was a suitable parameter for controlling the indoor environment: mass with high inertia was able to follow the trend of the outside conditions. On the contrary same mass was not really effective in the response to fast changes in the operative temperature and was affected strongly by that parameter. Slow response due to the high inertia also influenced the temperature pattern when natural ventilation was used: the ceiling structure was not able to cope with the fast increase of the temperature of the supplied air and comfort conditions changed depending on which of the two ventilation system was adopted.

Panel system was able to maintain temperatures close to the setpoint values. In absence of any significant storage capacity, the radiant ceiling could effectively follow the rapid variation of the internal operative temperature both in winter and in summer situation. Comfort was not affected by the use of natural ventilation since the ceiling ran in concomitance with the ventilation system and it could adjust rapidly the surface temperature according to the needed load (category A and B for more than 85% of time).

Radiant floor run during occupation time. Involving more mass than a ceiling panel, the response of this system was not as fast as for the previous case. In order to guarantee a certain comfort from the beginning of the occupational time in the morning, the system had to start to work from the early hours, especially on Mondays during winter season. However in the most critical situations, radiant floor was not able to keep temperatures within comfort range and in case of natural ventilation, higher values of temperatures in summer could not be avoided.

Thermal comfort was also analyzed by a value indicating in which extent temperatures were close to neutral values: area as shown in figure 8 was calculated for each case. Results obtained in [°C·h] were then normalized to the reference case, which was assumed to have the index equal to 1 (figure 9).

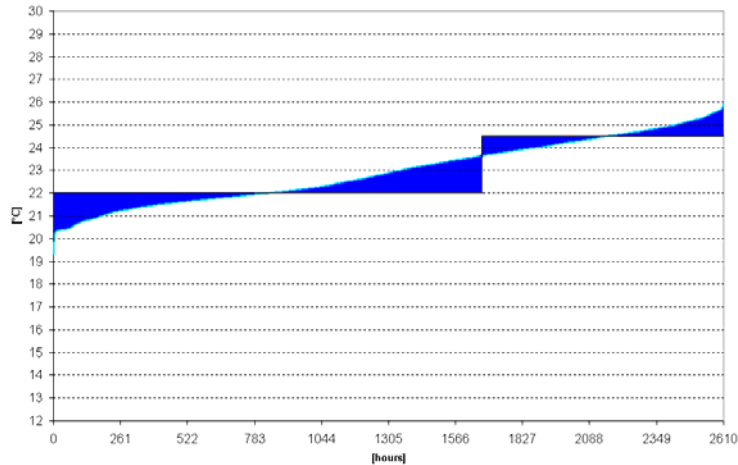

Figure 8 - Example of the calculation of the index. Neutral temperatures were set to 22°C and 24.5°C. The change from winter to summer condition was evaluated considering the profile temperatures of the reference case

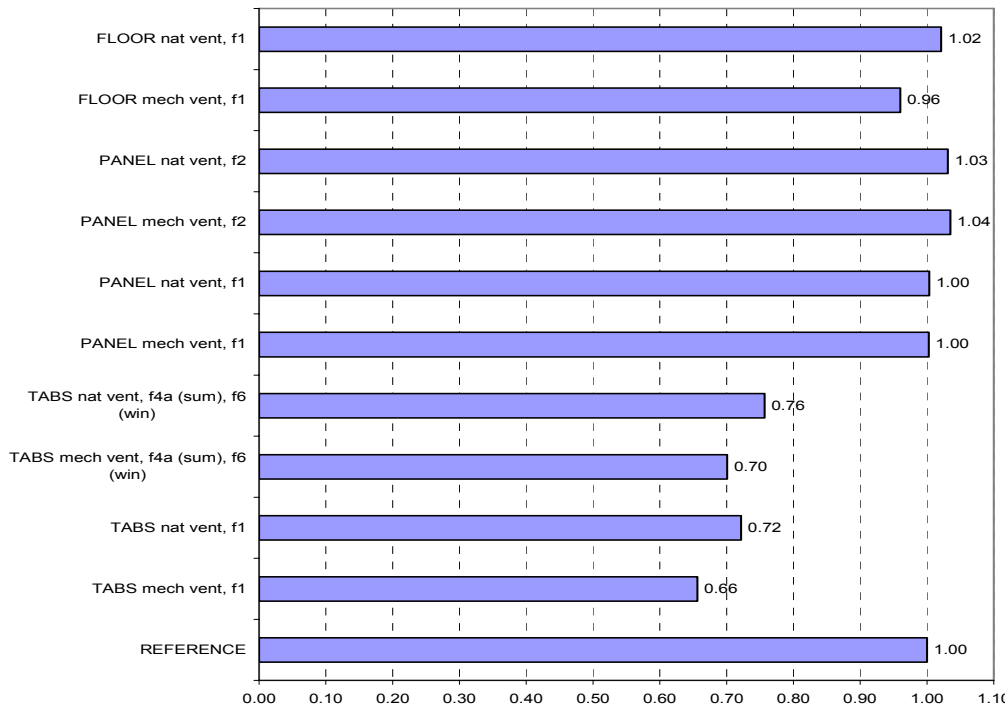

Figure 9 – Comparison of comfort achieved in each condition referred to the reference case. Evaluation by means of index calculated as shown in figure 8

Despite this indicator could vary and change depending on the chosen procedure and on the definition of winter and summer period, it sustained as well better performance of TABS.

2.4.1 Energy performance

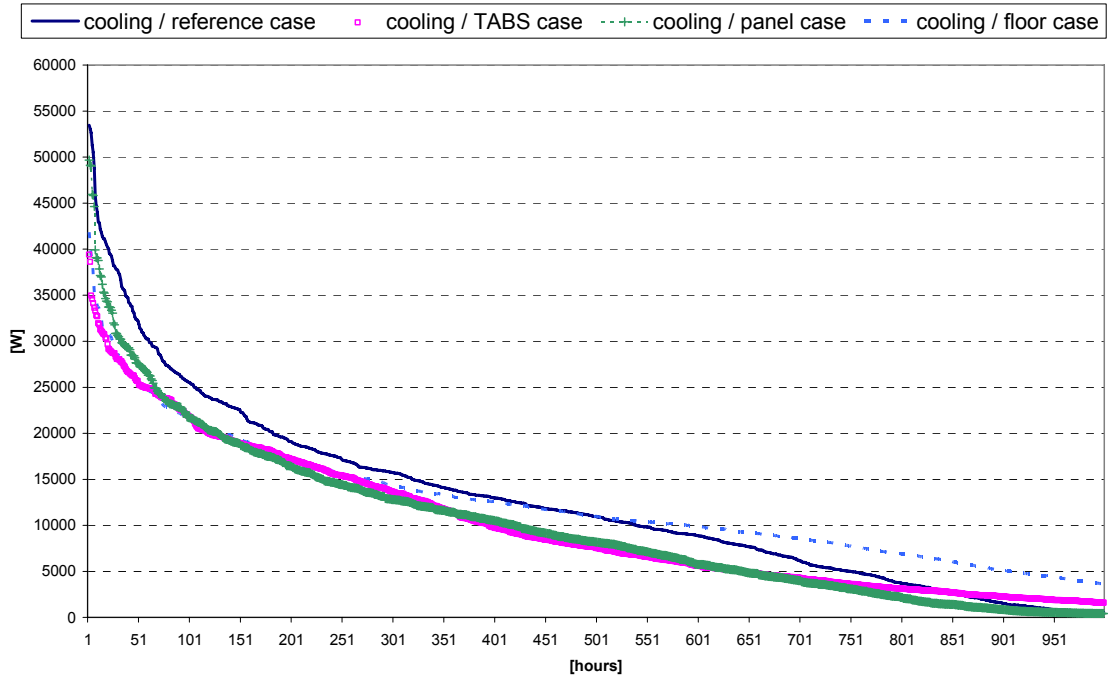

Figure 10 – Delivered power peak demand for each system

Concerning the power peak demand, storage capacity of concrete slabs allowed the system to run during night hours and to utilize the heat stored (or removed) in the day time: air and hydronic systems never worked at the same time, thereby reducing the power peak demand by the use of TABS in the cooling mode of 26% respect to full air system, 20% to the panel system and 6% to the floor system.

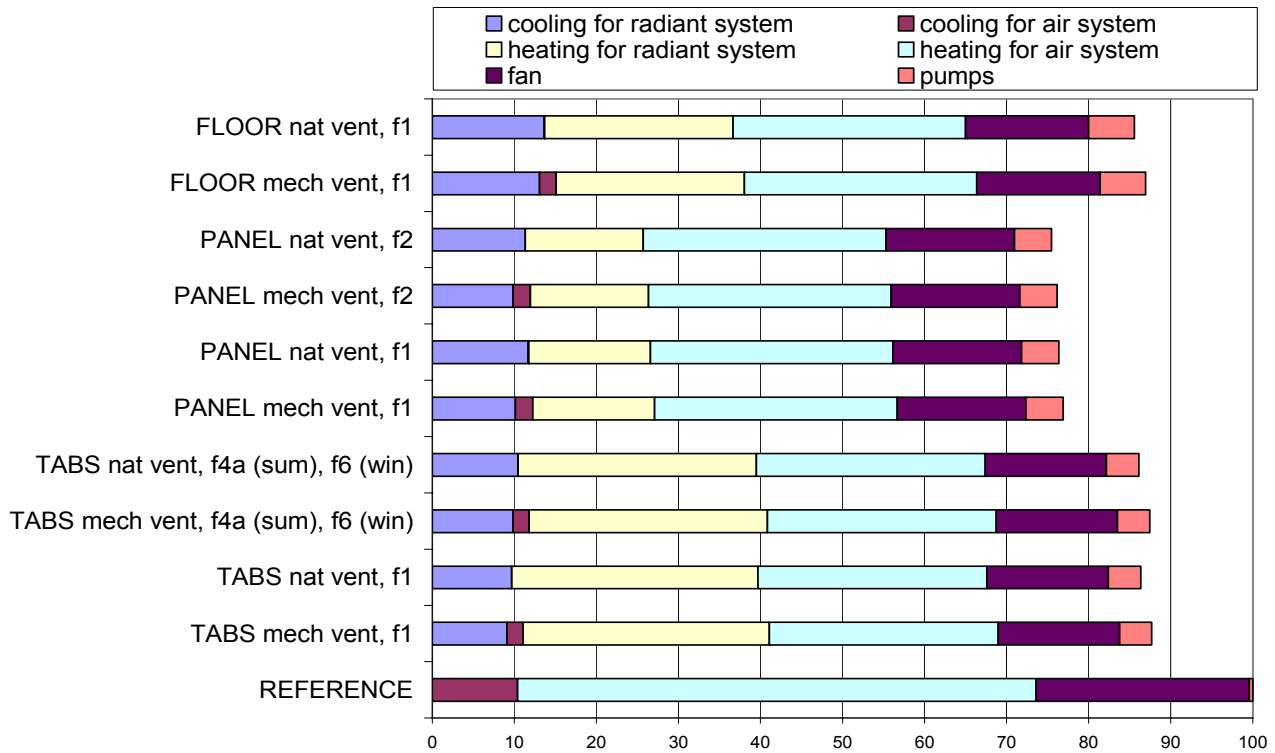

Figure 11 - delivered energy demand related to the reference case

Reference case represented a base situation where no recirculation or recovery was assumed. High demand for the heating season was mainly due to the cold condition of the climate data chosen, where outside temperature values rarely exceeded 17°C.

Cases with ceiling panel reached best performance due to the effective fast response and the limited number of operating hours, compared to radiant floor. Heating demand in the ceiling panel cases decreased up to 50% compared to TABS cases and 30% to floor cases.

Higher heating demand in TABS cases were due to higher comfort provided. In summer the performance of TABS increased significantly: by running in the night with moderate outside temperature, the efficiency of the system increased and higher COP values were reached. Energy consumption of the concrete cooling slab was 10% less compared to ceiling cooling panel and up to 30% less respect to cooling floor.

In the calculation of the coefficient of performance, different chiller/heat pump were chosen, sized according to the power demand of each case. During the cooling season, average values of COP obtained for the chiller were respectively:

Table 4- Average values of Coefficient of Performance for different systems

	TABS	Ceiling panel	Floor
Summer	6.2	5.0	5.2
Winter	3.6	3.1	3.2

TABS system improved the efficiency of the chiller / heat pump: running in the night with higher temperatures for cooling and lower temperatures for heating, cases with thermal activated building systems reached higher values of COP.

No considerable improvements were detected by adopting natural ventilation and letting the supply air temperature increase: temperature overshoot 17°C for few hours and no remarkable difference existed between the two conditions.

Convenience and suitability of a natural ventilation system is strictly related to the climatic zone considered and the trend of external temperature during the day, thereby different conclusions may be found in case of higher outside temperature.

2.5 Conclusions

Reference case had to be considered a general example of a full-air system, as base for the comparison: dead band method was the reason for certain fluctuation of the operative temperature. Energy demand represented the highest case, since operative temperature setpoint was fixed as constant value, and temperatures were not allowed to drift beyond the boundaries of comfort range during the day.

All the radiant systems, acting upon the mean radiant temperature, enhanced the comfort conditions and were able to keep operative temperature within limits for a large amount of time. TABS showed better results in terms of comfort achieved, even though the energy demand for heating was significant and better adaptation needed to be investigated.

Ceiling panel represented a feasible solution in terms of comfort and energy demand. Their characteristic of having low inertia and fast response permitted a more flexible and efficient control, each hour proper for the load required.

Generally all the radiant hydronic systems constituted a feasible and promising solution compared to conventional full-air systems. Advantages were achieved both in indoor comfort conditions and in the energy performance, as peak values and overall energy consumption.

Effectiveness of coupling radiative systems with ventilation is deeply related to an appropriate adaptation and control. Future investigation need to be carried out in this direction.

2.6 Temperature profile plots

2.6.1 Temperature profiles, cooling and heating season, mechanical and natural ventilation.

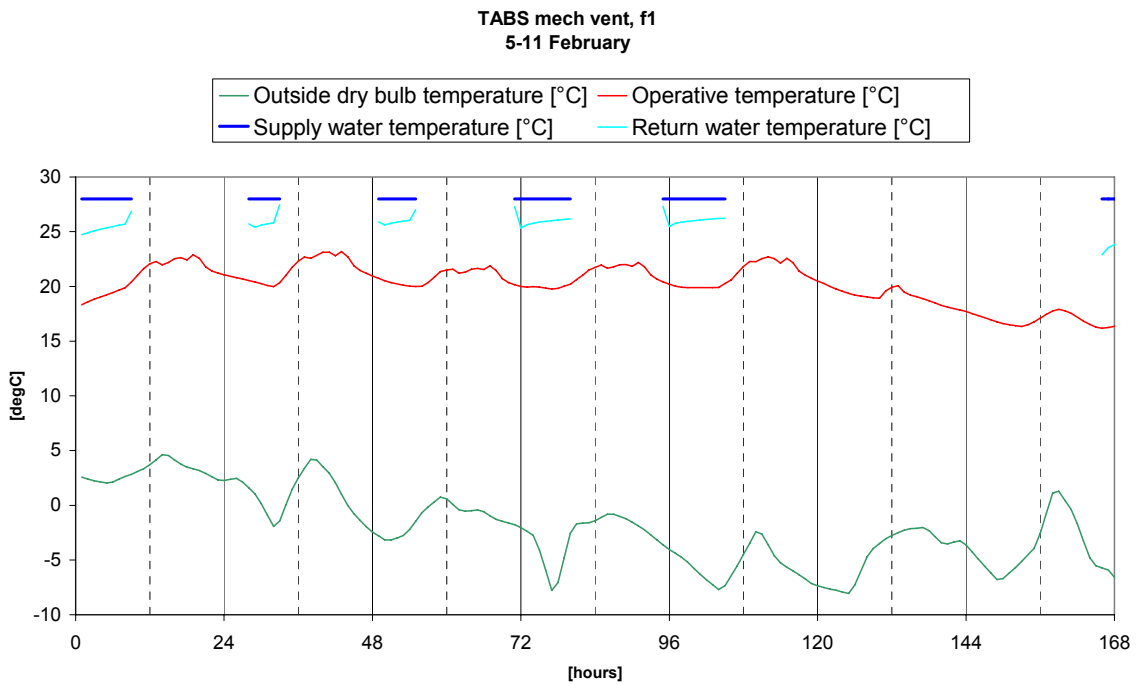
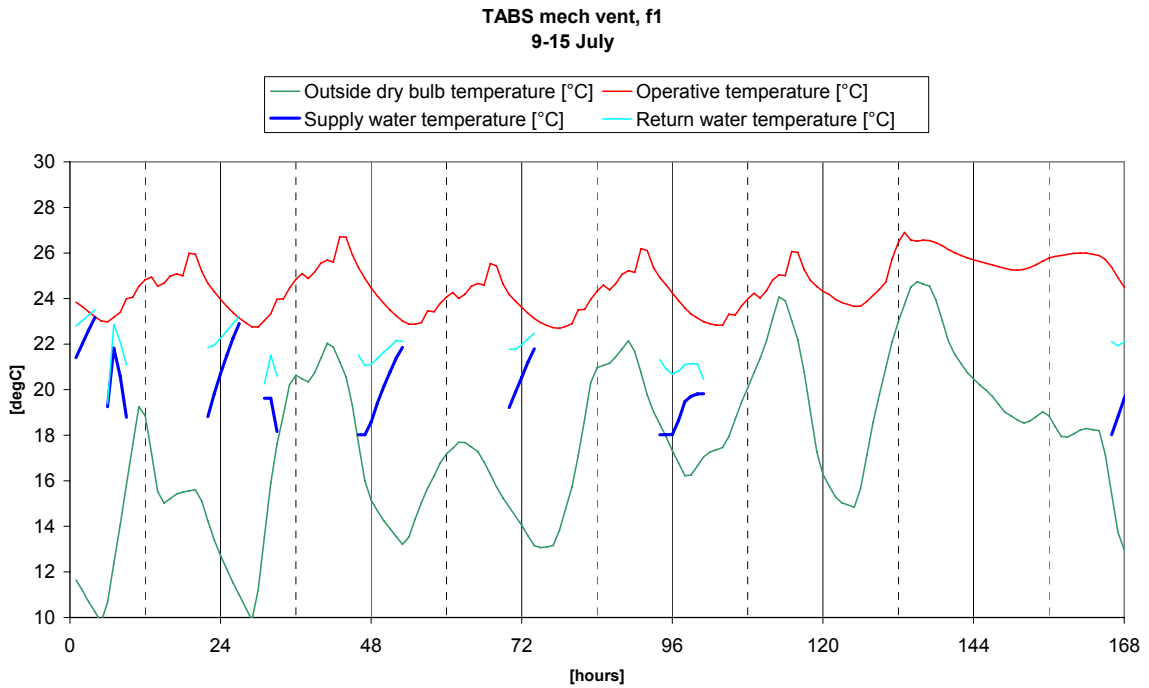

FLOOR nat vent, f1
9-15 July

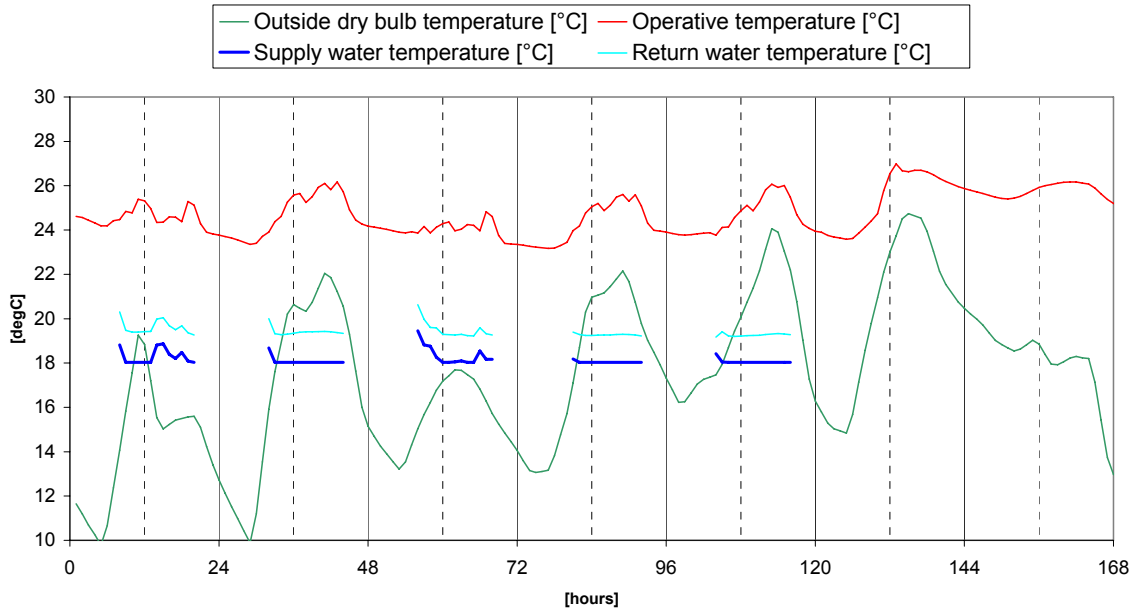

FLOOR nat vent, f1
5-11 February

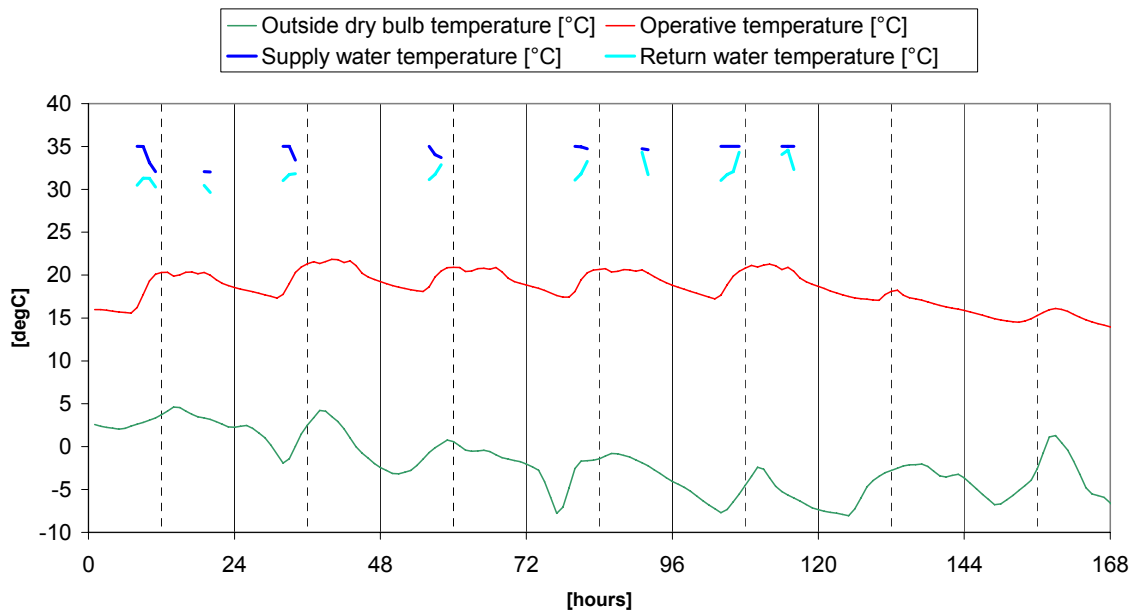

PANEL nat vent, f2
9-15 July

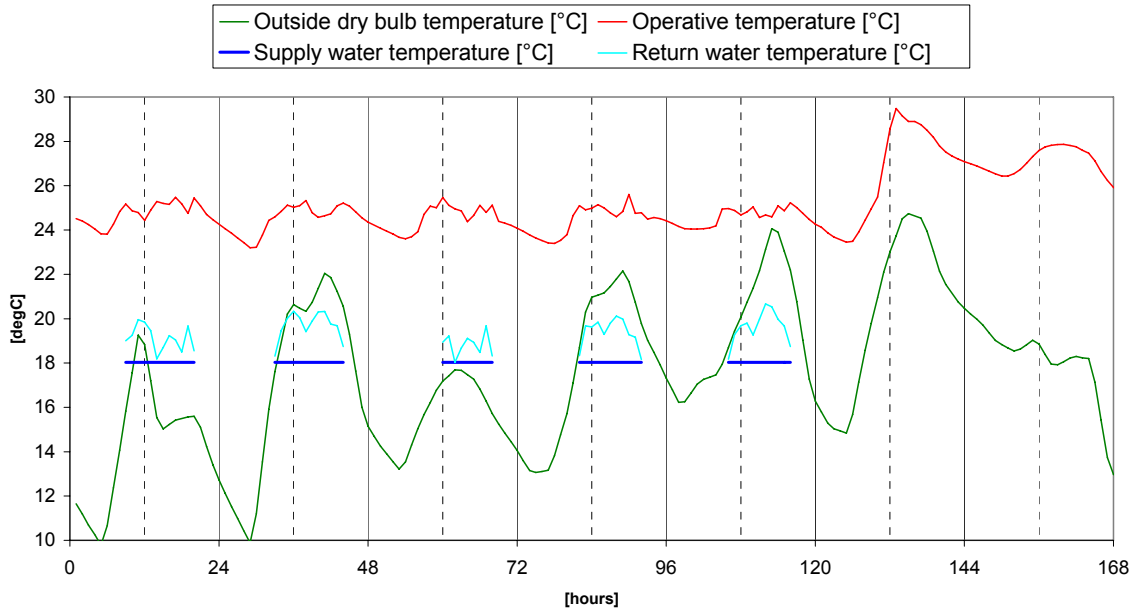

PANEL nat vent, f2
5-11 July

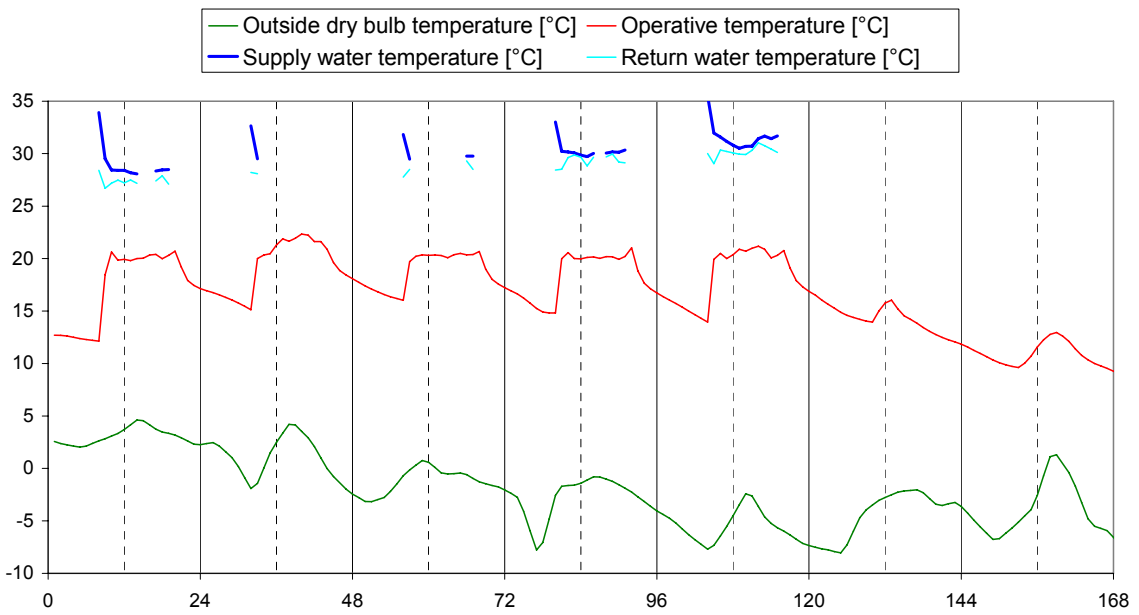

3 Description of selected ECMs

3.1 Solar wall for outdoor air preheating

Application: Industrial

Category: Building Envelope/HVAC System

Description: An unglazed “solar wall” preheats ventilation air by drawing make-up air through a perforated steel or aluminum plate that is warmed by solar radiation. The solar wall consists of perforated steel or aluminum cladding attached to the south façade of a building with an air gap between the existing wall and the cladding. The solar wall is dark-colored to absorb the maximum amount of solar radiation. Air is drawn through the small holes in the wall and heated at the same time. The warm air rises to the top of the wall and is drawn into the building’s ventilation system as shown in the figure below.

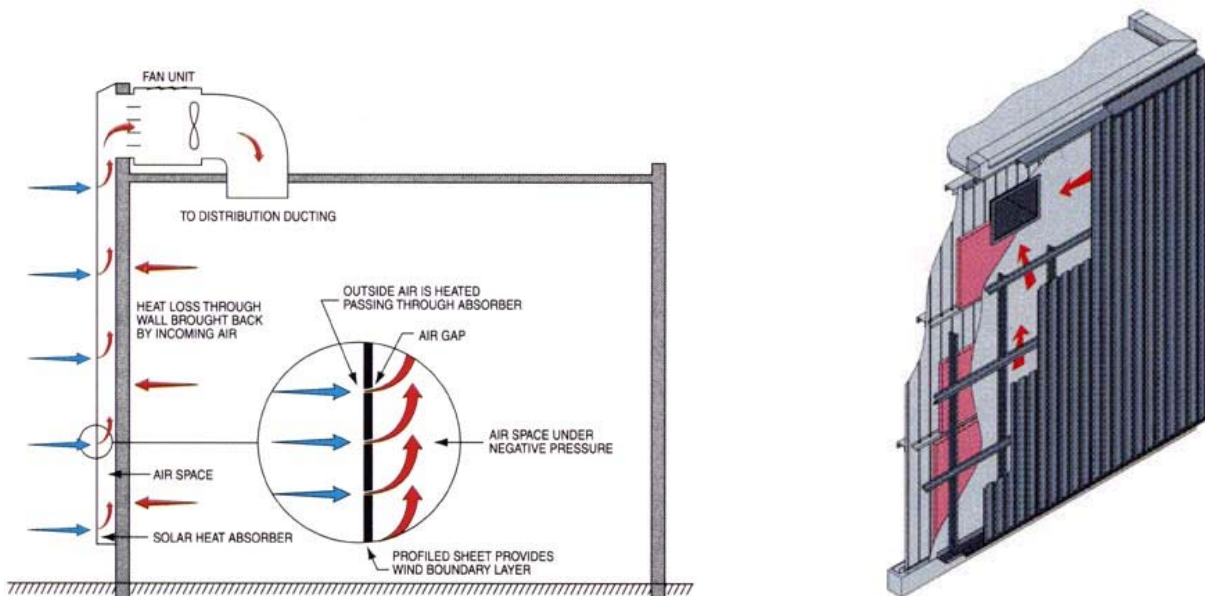

Schematic of air flows through a solar wall (a) and typical installation (b). (www.solarwall.com)

Concept: The performance of an unglazed, perforated (‘transpired’) solar wall depends primarily on four parameters: the solar reflectance of the wall, the orientation of the wall, the size and spacing of the perforations in the wall and the pressure drop maintained by the ventilation system across the wall. The solar reflectance is primarily affected by the coating applied to the solar wall. In general, darker colors have a lower reflectance, and thus absorb a greater fraction of incident solar radiation. The orientation of the wall also greatly affects its performance. The intensity of the incident solar radiation is dependent on the cosine of the ‘angle of incidence’, the angle between the outward facing normal of the surface and the ‘line of sight’ to the sun. Walls that more directly face the sun will receive more solar radiation. In winter months in the northern hemisphere, south facing walls perform best. The cost effectiveness of applying solar collectors to East and West facing walls (to catch morning and afternoon sun) must be analyzed on a case by case basis.

The size and spacing of the perforations along with the pressure drop across the wall due to the operation of the ventilation system largely determines the impact of wind speed and wind direction

on the solar wall performance. For a properly designed wall with small closely spaced perforations and a relatively high pressure drop, the laminar boundary layer created by suction at the wall will largely negate the effects of changing wind speed and wind direction. Below in the figure is a graph showing the temperature rise of incoming air versus solar radiation intensity for different airflow rates. It can be seen that for low ventilation airflow rates, the temperature rise can be as large as 75°F. For high airflow rates, the temperature rise can be as large as 30°F.

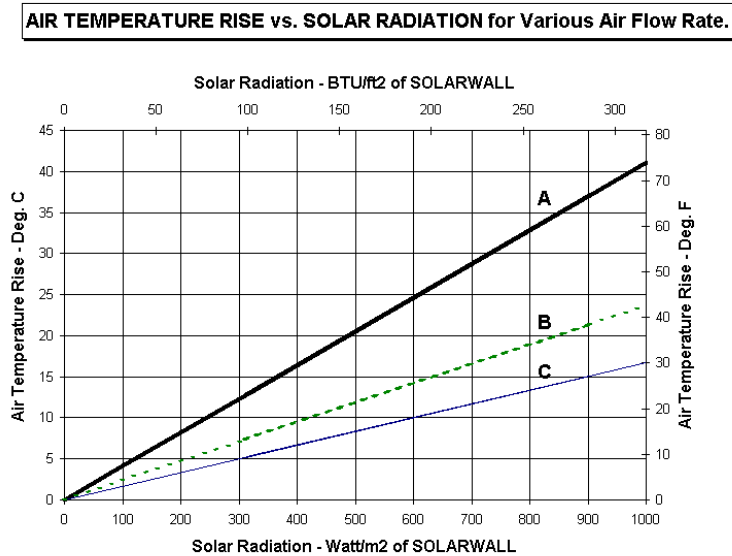

Graph illustrating temperature rise vs. solar radiation intensity. A low flow rate, C high flow rate. (www.solarwall.com)

Potential Energy Savings (Qualitative): Transpired solar wall technology is beneficial in applications where heating loads exist, a high ventilation flow rate is required and a large south-facing facade is available for cladding. The shortest payback is achieved by designing a system that will maintain an adequate pressure drop across the wall during all or most hours of operation. In the summer, the ventilation air is drawn directly into the HVAC system, bypassing the solar wall. The air in the cavity behind the solar wall naturally flows through holes at the top of the cladding.

Potential Energy Savings (Quantitative):

The installed cost of a transpired solar wall system varies from \$20/ ft² for a basic industrial application (left below) to \$25/ ft² for an architecturally designed façade (right below)



a. Typical Industrial Application
Façade

b. Architecturally Designed

Transpired Solar Wall Applications

Energy Savings and Payback Calculation Assumptions:

5536 ft² (514.3 m²) of solar walls were added to the all of the southern wall and half of the western wall. The solar walls were made up of a transpired collector that allowed the HVAC system to pull all of its make up air requirements through the solar wall, effectively preheating the outside air. The system was run off a controller so that air was only drawn through the walls while in heating mode. The transpired collector had the following properties:

- Diameter of Perforations: 0.00525 ft (0.0016 m)
- Perforation Pitch: 0.055 ft (0.01689 m)
- Perforation Pattern: Triangle
- Thermal Emissivity: 0.9
- Solar Emissivity: 0.9
- Thickness of Plenum: 0.328 ft (0.1 m)
- Collector Thickness: 0.00282 ft (0.00086 m)

A cost of \$20/sq. ft. which is a typical new construction cost for industrial buildings was assumed.

Energy Savings and Payback Calculation Results:

The results show that savings were significant in every climate that required heating. For the industrial building with high ventilation flow rates, the payback was under two years for all but the four cooling dominated climates.

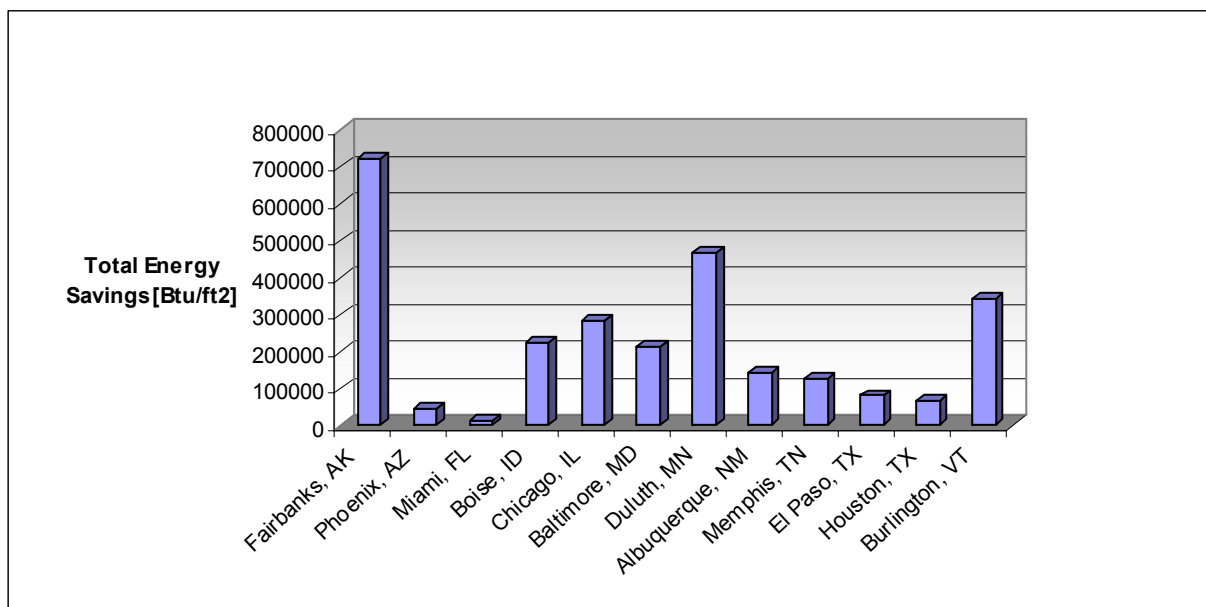

Transpired Solar Wall Total Energy Savings Per Square Foot of Total Floor Area

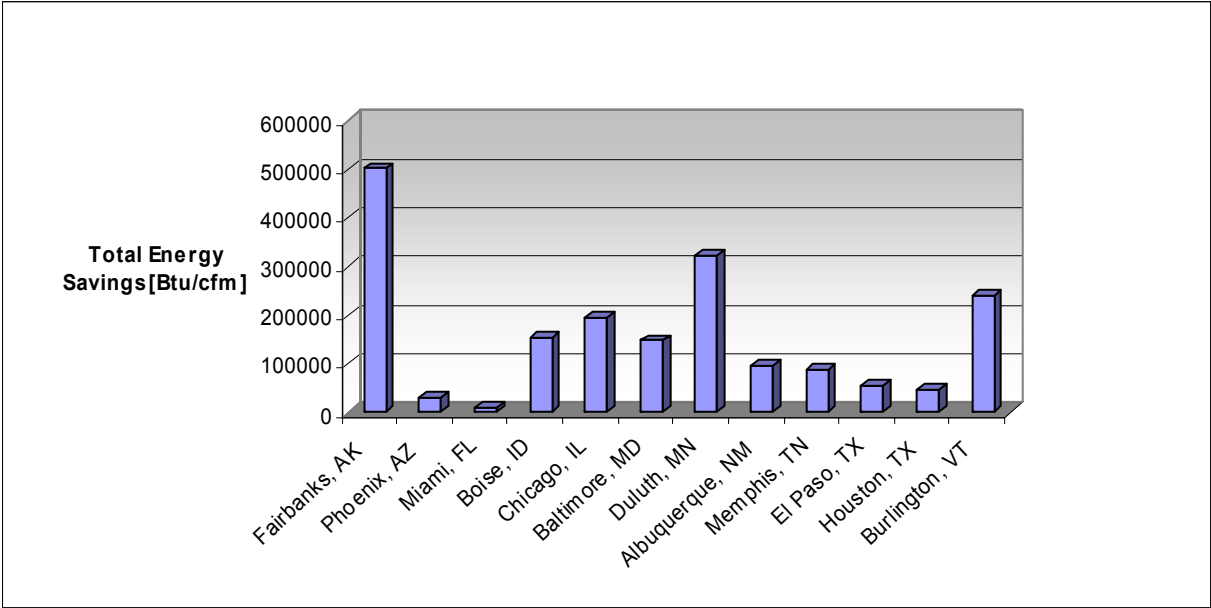

Transpired Solar Wall Total Energy Savings Per Cubic Feet Per Minute

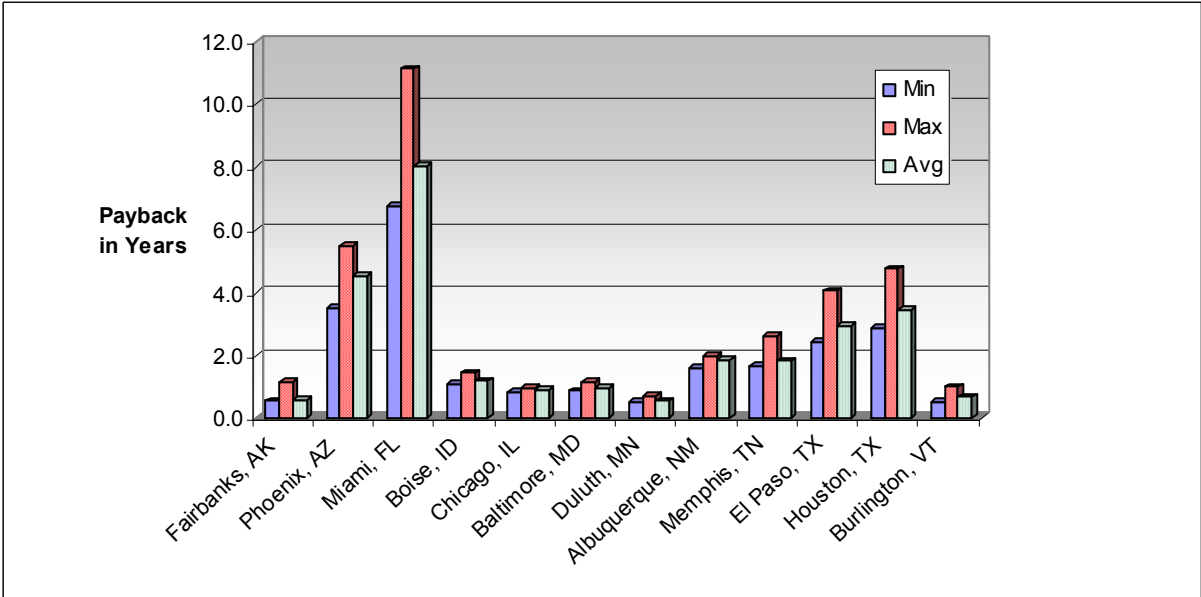

Transpired Solar Wall Estimated Payback Shown for High, Medium and Low Energy Rates

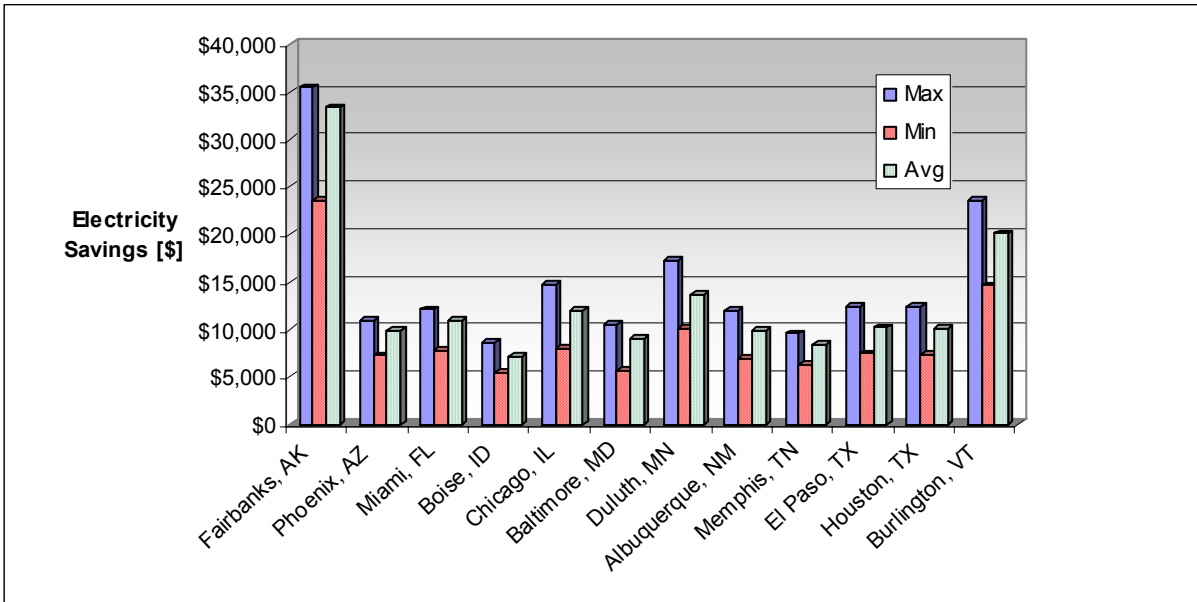

Transpired Solar Wall Estimated Electricity Savings Shown for High, Medium and Low Energy Rates

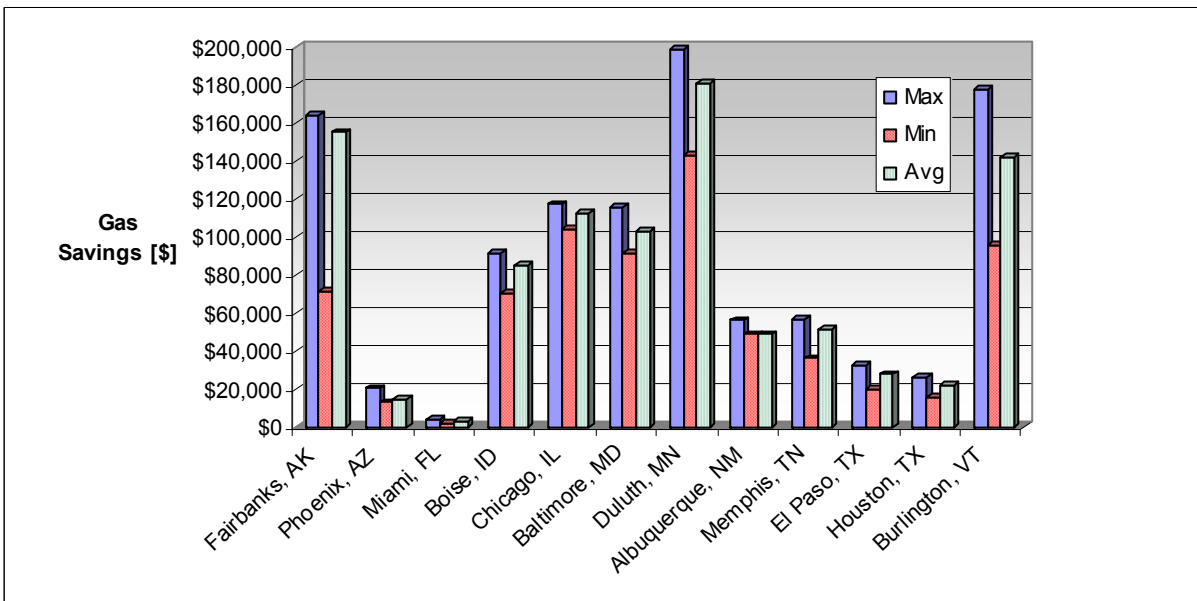

Transpired Solar Wall Estimated Gas Savings Shown for High, Medium and Low Energy Rates

Transpired Solar Wall Estimated Energy Savings and Installed Cost

Location	Annual Electric Savings [KW-hr]	Annual Gas Savings [Therms]	Installed Cost	Maintenance Cost [\$]
Fairbanks, AK	295709.8125	351246.34	\$20/sq. ft.	\$0
Phoenix, AZ	134232.7031	18042.8	\$20/sq. ft.	\$0
Miami, FL	134117.75	2566.39	\$20/sq. ft.	\$0
Boise, ID	145128.3906	106953.77	\$20/sq. ft.	\$0
Chicago, IL	178151.6875	135475.83	\$20/sq. ft.	\$0
Baltimore, MD	140601.2344	101809.98	\$20/sq. ft.	\$0
Duluth, MN	223330.6562	225088.9	\$20/sq. ft.	\$0
Albuquerque, NM	139565.4062	65756.75	\$20/sq. ft.	\$0
Memphis, TN	138585.1719	59002.51	\$20/sq. ft.	\$0
El Paso, TX	135682.6562	35704.84	\$20/sq. ft.	\$0
Houston, TX	134187.625	28567.83	\$20/sq. ft.	\$0
Burlington, VT	182743.1407	166557.19	\$20/sq. ft.	\$0

Level of Maturity: The technology was first proposed in the early 1990's and is supported by research results from the National Renewable Energy Laboratory and field experience.

Impact on Indoor Air Quality: Ventilating air in a zone increases the quality of indoor air by removing the contaminants in the room. With preheated air, ventilation can be increased, thus increasing the quality of indoor air.

Practical Experience: Conserval Engineering is the main North American manufacturer. They have been designing transpired solar walls for 15 years and have an installed base of 1,000,000 ft² of solar wall

Major Manufacturers: Conserval Engineering Inc. Toronto, ON

References: www.solarwall.com

Climatic Conditions Necessary: The technology works equally well in any climate, however it is a heating technology which will find its major application in cold and temperate climates. The typical number of clear days in a climatic region should also be considered in the application of the technology

Contacts: Conserval Engineering Inc.
200 Wildcat Rd., Toronto, ON M3J2N5
Tel: 416-661-7057
Email: info@solarwall.com

National Renewable Energy Laboratory
1617 Cole Blvd., Golden, CO 80401-3393
(303) 275-3000
http://www.nrel.gov/learning/re_solar_process.html

3.2 Radiant floor heating and cooling systems.

Category:

HVAC and building

Application:

Residential, Industrial, Office Buildings, gymnasium halls etc

Description:

Embedded systems insulated from the main building structure (floor, wall and ceiling) are used in all types of buildings and work with fluids at low temperatures for heating and relatively high temperature for cooling.

Significant attribute of this system is to minimize thermal coupling of the emitting element (e.g. pipe coil and screed) with the main building structure (ceiling or wall). Separating layer of thermal insulation in form of polystyrene or mineral wool boards can be placed between building structure and screed (pipes). The heat flux of 10% comes anyway through the separation layer to the backside.

This type of radiant system is quite increasingly been used mostly in German speaking and Nordic countries, especially in new buildings (but also in renovations), because it does not introduce more work on the structures, achieves better view factors with people and safety space without danger of injury. The pipe distribution inside the concrete layer can vary both as hydraulic circuit (pipes in series or in parallel) and as a geometrical distribution.

Most common type is floor systems; but also wall and ceiling systems can be used in special constructions.

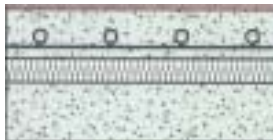

Floor system

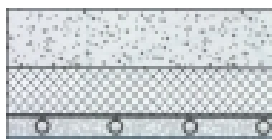

Ceiling system

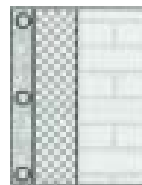

Wall system

Figure1 - Examples of water based radiant systems [16]

Some floor systems are made by extruded plastic material which forms micro (capillary) channels. In this case the heat exchange surface is very wide, which allows very low temperature differences. Moreover the thickness of this system is very narrow, thus they can be used in renovations.

In the last years the use of capillary pipes embedded in gypsum board under the ceiling has been proposed.

System types with pipes isolated from main building structure:

- in the screed or concrete, type A
- outside of the screed (e.g. in the thermal insulation layer) type B
- in the screed, type C
- Plane section systems, type D

- Massive concrete systems E
- Capillary tube systems F
- Wooden construction, type G

The following describes the different type of systems exemplified by floor systems.

Type A: System with pipes embedded in the screed or concrete

System with pipes “wet” embedded in a screed (Figure 2) is the most common form of floor heating in Europe. After the placing the pipe coil on the thermal insulation, the screed is applied so the pipes are fully fixed and the screed appropriately performs heat conduction from heat carrier medium through pipes to the emitting surface.

The cement, anhydride or magnetite structure of screed can be used. The available structure is shown in Figure 2 [C2].

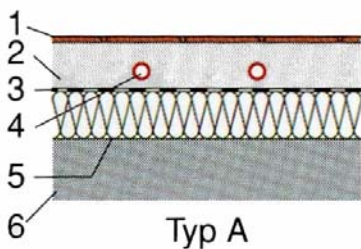

Figure 2 Floor structure type A (EN15377-1 and EN1264-2) [27]:

- 1 Floor covering
- 2 Screed
- 3 PE foil
- 4 Pipes
- 5 Thermal insulation
- 6 Ceiling/Building structure

Type B: System with pipes embedded outside of the screed (e.g. in the thermal insulation layer)

The heat carrier pipes are bedded in system plates (Figure 3, Figure 4), which separate as the thermal insulation layer. As the heat transfer crosswise from pipe to pipe is by the system plates limited, the temperature differences in the pipe level may occur. For the better temperature distribution the heat conducting elements (Figure 4) are used. The conducting plates perform properly when there is an accomplished connection and pipes are optimal bedded. The disadvantage of this critical detail connection can be reduced (compensated) with the increase of the heat carrier supply temperature.

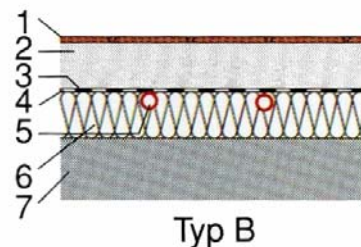
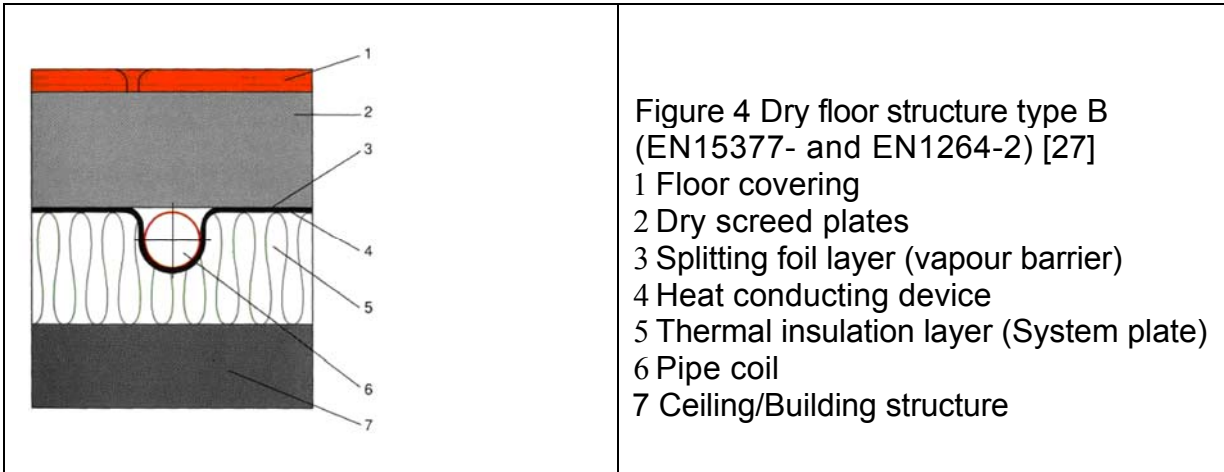

Figure 3 Floor structure type B (EN15377- and EN1264-2) [27]:

- 1 Floor covering
- 2 Screed
- 3 PE foil
- 4 Heat conducting plate (device)
- 5 Pipe coil
- 6 Thermal insulation
- 7 Ceiling/Building structure



Depending on the material of the “dry” screed element (e.g. metal conducting plates) the heating pipes level temperature cannot be increased arbitrarily (without limit), thus the heat capacity is lower than by the “wet” floor heating structure. Figure 4 shows the possibility of the “dry” system structure.

Type C: System with pipes embedded in the screed

The heating element (pipe coil) for the system type C is placed to the levelling layer, above which the second screed layer with two splitting foil layers is placed (Figure 5).

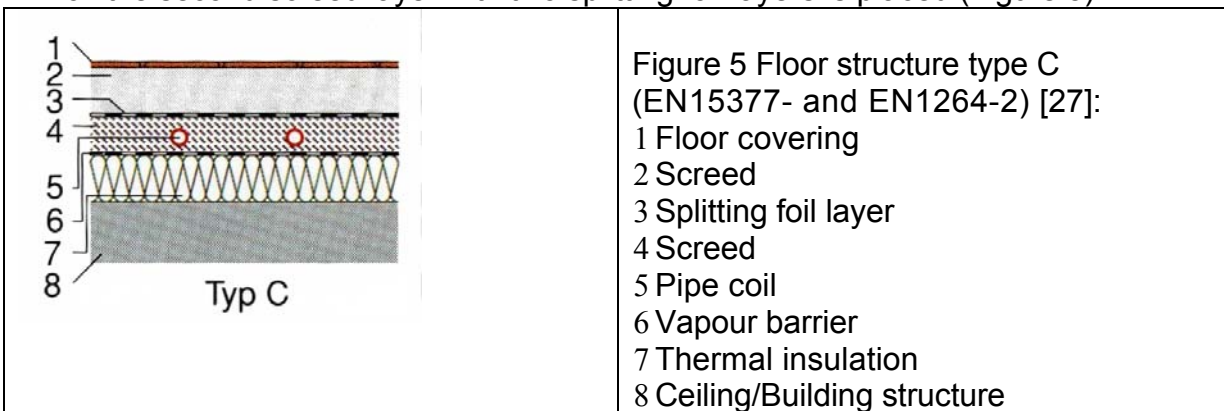

Type D: Plane section systems

Instead of the group of solo plastic pipes this system consists of extruded plastic panels created by the group of micro capillary grids of channels as plane section. In this case the heat exchange surface is very wide, which should theoretically allow very low temperature differences.

The module made of PEX board of 5mm thickness can create a very narrow floor structure, thus they can be used in retrofit.

Type G: System with pipes embedded in a wooden construction

The piping may be applied also on or under suspended wood floors (walls or ceilings) using several methods of construction. Piping may be attached to the surface of the floor or may be embedded in a layer of concrete or gypsum, mounted in or below the sub floor, or attached directly to the underside of the sub-floor using metal panels to improve heat transfer from the Piping level (figure 7 and 8)

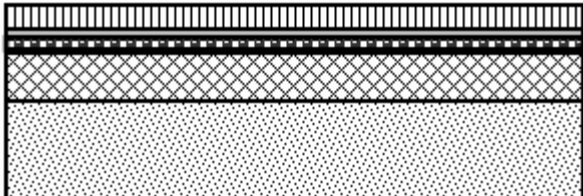

Figure 6 Heating cooling floor with plane section system type D, with floor surface covering, screed material, plastic plane section boards, and building structure (EN1264-2)

..

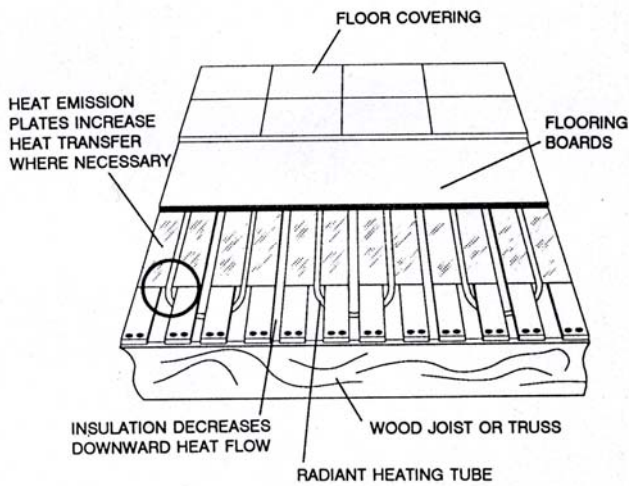

Figure 7 a Pipe in sub floor, type G (EN15377)

Figure 7 b System construction

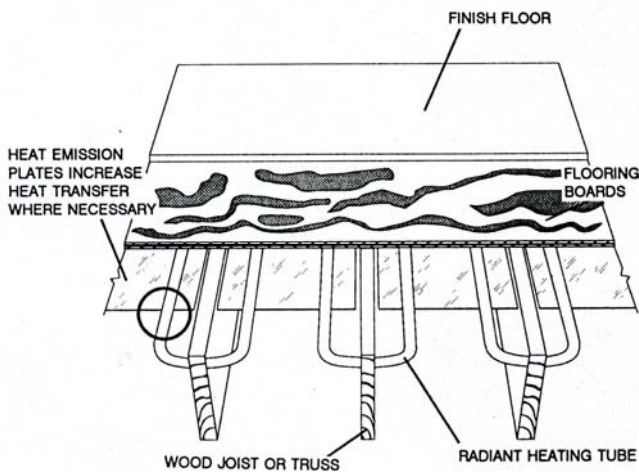

Figure 8 a Pipe under sub floor, type G (EN15377-1) [1]



Figure 8 System construction [C21]

As illustrated in Figure 7, tubing may be installed in the sub floor. The tubing is installed on top of the rafters between the sub flooring members. Heat transfer is improved by the addition of metal heat conducting plates which spread the heat beneath the finished flooring. A second construction option (Figure 8) is to attach the tube to the underside of the sub floor with (or without) metal heat conduction devices.

Concept

Embedded surface heating and cooling systems are used for all type of buildings (residential, apartments, large spaces, gymnasium halls, churches, industrial buildings, hospitals, etc. The most common system is a floor system, which in the following is used as reference.

Transfer from the hot water pipes to the surface of the floor is the important consideration in all cases.

Thermal energy is exchanged by at least 50% by radiation between the room and people present in the space and the heated or cooled surfaces. For the same surface to room temperature difference a surface will exchange the same amount of heat independent of the sub-surface system.

The relationship between heat flow density and mean differential surface temperature so called Characteristic Curve (Fig. 4.2 and Equations (4.1) to (4.4)) depends on the type of heat emitting surface (floor, wall, ceiling) and if the temperature of the surface is lower (cooling) or higher (heating) than the space temperature. Heat exchange coefficient is parameter that in a most affects the amount of heat transferred between surface and the space related to the over listed types, if the same mean differential temperature is assumed.

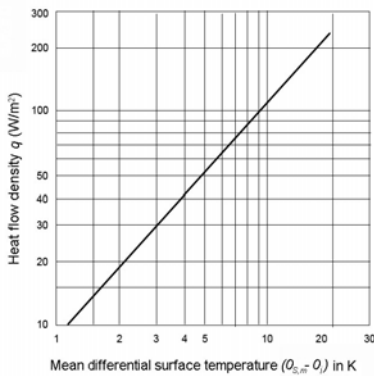

Figure 9 - Basic characteristic curve for floor heating and ceiling cooling

$$\text{Floor Heating and Ceiling Cooling} \quad q = 8,92 (\theta_i - \theta_{S,m})^{1,1} \quad (1)$$

For other types of situations the following relations shall be used:

$$\text{Wall heating and Wall cooling:} \quad q = 8 (|\theta_i - \theta_{S,m}|) \quad (2)$$

$$\text{Ceiling Heating:} \quad q = 6 (|\theta_i - \theta_{S,m}|) \quad (3)$$

$$\text{Floor cooling:} \quad q = 7 (|\theta_i - \theta_{S,m}|) \quad (4)$$

It is here assumed that the room temperature is the operative temperature.

For most type of systems the heating-cooling capacity can be calculated according to EN1264-1 and 5 or EN15377-1. The assumption from Table 1 (Criteria for selection of simplified calculation method based on EN15377-1) has to be fulfilled. For other systems EN1264-1 describes a test method.

Two types of simplified calculation methods can be used, according to EN15377-1 . One performs using Single Power Function Product of all relevant parameters developed from the Finite Element Method (FEM), following EN1264 (now applied to and can be applied for system types A-D. The second is based on a calculation of equivalent thermal resistance between the temperature of the heating/cooling medium and the surface temperature (or room temperature) suitable for types E-G.

Impact on the indoor environment.

The room thermal comfort is maintained primarily by radiant heat transfer instead of convective heat transfer. An important factor for the thermal comfort of occupants is the mean radiant temperature. The maximum surface temperature depends on the criteria for radiant asymmetry (ceiling, wall) or direct contact with the surface (floor, wall).

Table 1 Criteria for selection of simplified calculation method based on EN15377-1 and EN1264-2 and 5.

Pipe position	Type	Boundary conditions	Method of capacity calculation
In screed, one side loss less than or equal to 10% of total	A, C	$T \geq 0,050$ m $S_u \geq 0,015$ m $0,01 \leq d \leq 0,03$ $S_u / \lambda_e \geq 0,0208$ $0,6 \leq X_e \leq 2,0$	Universal single power function $q = B \cdot a_B \cdot a_T^{m_T} \cdot a_D^{m_D} \cdot a_U^{m_U} \cdot \Delta\theta_H$
In insulation, conductive devices, one side loss less than or equal to 10% of total	B	$0,05 \leq T \leq 0,045$ m $0,014 \leq d \leq 0,022$ $0,02 \leq S_u / \lambda_e \leq 0,15$	Universal single power function $q = B \cdot a_B \cdot a_T^{m_T} \cdot a_U^{m_U} \cdot a_{WL} \cdot a_K \cdot \Delta\theta_H$
Plane section system	D		Universal single power function $q = B \cdot a_B \cdot a_T^{m_T} \cdot a_U^{m_U} \cdot \Delta\theta_H$
In concrete slab	E	$S_T / T \geq 0,3$ $d_a / T \leq 0,2$	Thermal resistance method $q_i = \frac{R_1}{R_1 + R_2} \cdot [R_1 \cdot (\theta_v - \theta_1) + R_2 \cdot (\theta_2 - \theta_1)]$
Capillary tubes in concrete surface	F		Thermal resistance method $q_i = \frac{R_1}{R_1 + R_2} \cdot [R_1 \cdot (\theta_v - \theta_1) + R_2 \cdot (\theta_2 - \theta_1)]$
Wooden constructions, pipes in sub floor or under sub floor, conductive devices.	G	$a_{wl} \geq 10$. $\lambda_{surroundingmaterial}$ $S_{WL} \cdot \lambda \geq 0,01$	Thermal resistance method $q_i = K_H \cdot \Delta\theta_H$

Studies show that a higher floor temperature will decrease the risk for house dust mites. The uniform temperature distribution from floor heating increases comfort especially in high ceiling buildings. The uniform temperatures and surface temperatures close to room temperature will avoid any transportation of dust. Because the systems are covered under the surface there is no risk for safety regarding people or machines getting in contact. Due to the small temperature difference between the heated-cooled surface the systems have a high degree of self control and stable room temperatures is obtained.

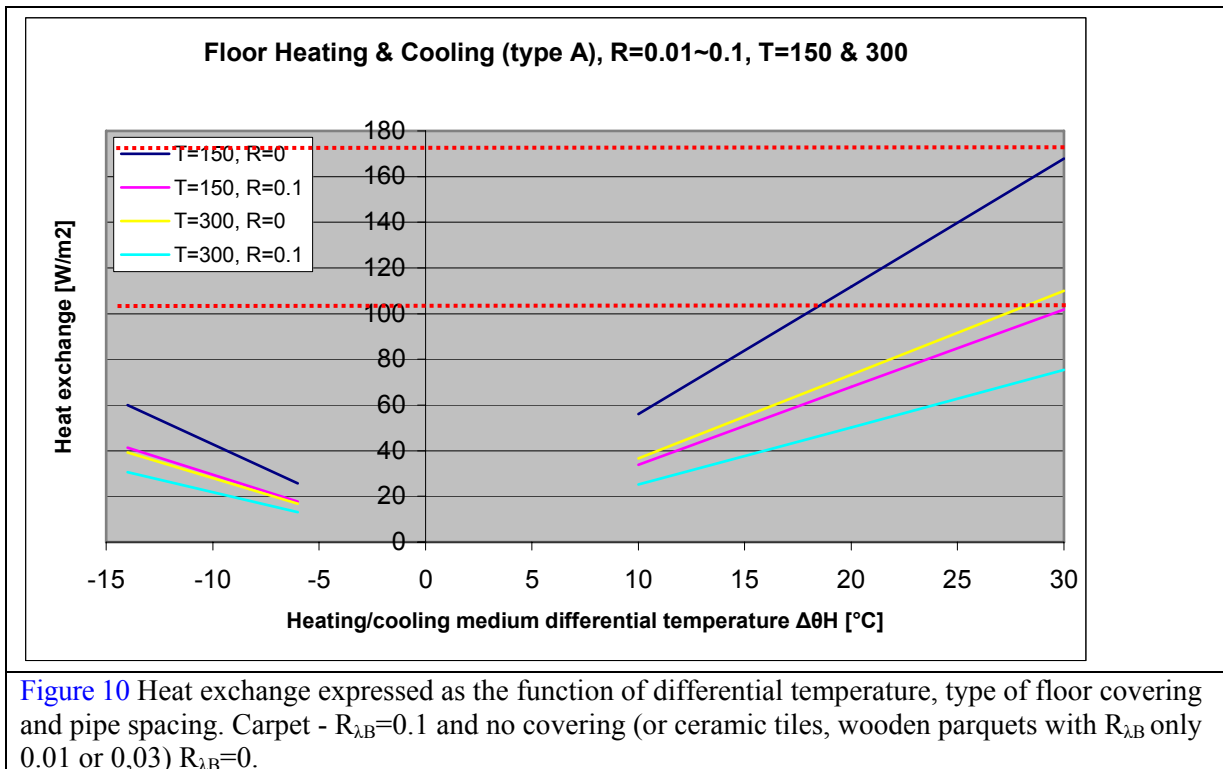

3.2.1 Potential Energy Savings (qualitative)

Compared to full air systems the following potential energy savings exist:

1. Transportation of energy by water instead of air. Auxiliary energy for circulation pumps less than fans
2. For same comfort level (operative temperature) a higher air temperature in summer and a lower air temperature in winter are possible. That reduces the ventilation/infiltration losses
3. The system uses higher water temperature for cooling and lower water temperature for heating. This will increase energy performance of boilers (condensing boilers), heat pumps, chillers etc.
4. Due to the use of water temperature close to room temperature the potential for use of renewable energy sources are increased (free cooling,

3.2.2 Potential Energy Savings (Quantitative)

To perform a yearly, dynamic computer simulation of such a system the heat transfer between surface and water in the pipes must be known. This can be found from the calculated or tested heat transfer according to EN15377-1 and EN1264-2 and 5, as an equivalent resistance between water temperature (average or supply). This equivalent resistance is then introduced into the building simulation. A critical factor in the dynamic calculation is the dynamic behavior of the systems. One method could be to include a specific heat capacity based on the material used. Finally to evaluate energy use on the waterside, it will be beneficial if the simulation program also can calculate the return water temperature, which will influence efficiency of boilers and chillers.

3.2.3 Energy Savings and Payback Calculation Assumptions

The cost of piping and mounting system will be in the range 20-40 € per square meter. In addition costs for supply and return water piping and installation costs. Maintenance cost is almost zero.

3.2.4 Simulation Results

Results of the energy simulations are included in a separate report

3.2.5 Environmental issues

In most cases the piping system is made of plastic resulting in a very low environmental emission during production. By demolition the pipes cannot be reused; but has a high embedded heating energy.

3.2.6 Level of Maturity

More than 30 years

3.2.7 Climatic Conditions Necessary

The technology works equally well in any climate, however it is mainly a cooling technology which requires consideration of the dew point in the space. In hot-humid climates dehumidification must be applied.

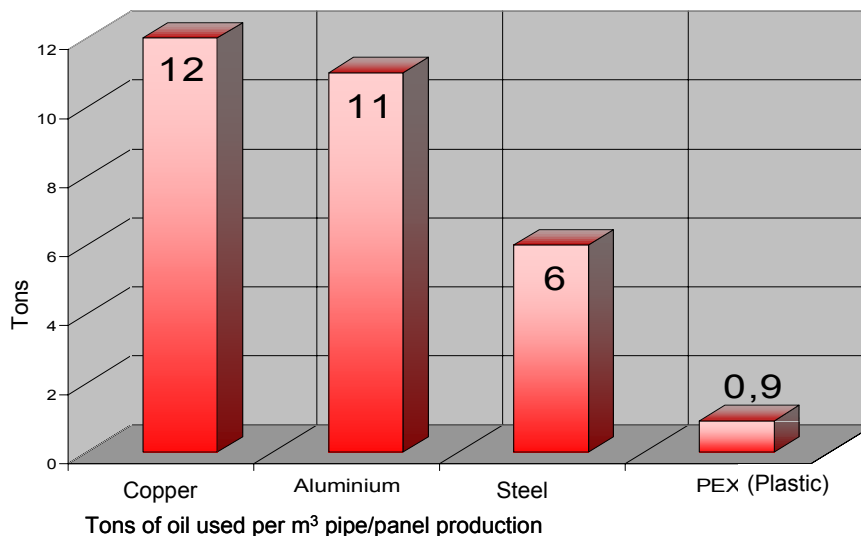

3.2.8 Contacts and Major Manufacturers

Main manufacturers are to be found in Europe (Zent-Frenger, UPONOR, ROTH, and Rehau). There also exist a European Association for surface heating and cooling systems (euray) and an American association (RAP)

3.3 Embedded surface radiant heating and cooling systems.

Category:

HVAC and building

Application:

Industrial, commercial and office multi-story buildings

Description:

The main difference between the other radiant systems and TABS is the possible asynchrony of the operation of the conditioning plant and thermal loads, i.e. the slab has the opportunity to store heat or cool in different time with respect to thermal loads. Purpose is to shift the loads to night time and operate using the cheaper night-tariff prices of electricity. The main applications are for cooling

Thermo Active Building Systems

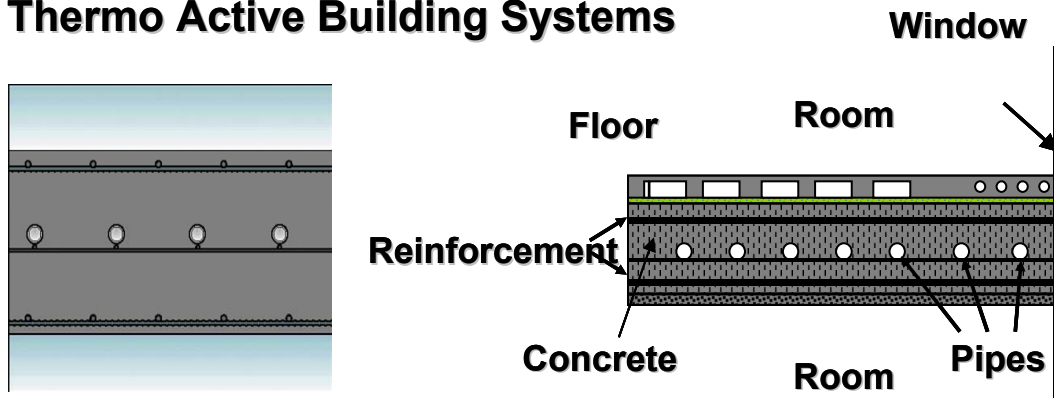

Figure 1 Thermo Active Building System

The peak-shaving is the possibility to heat and cool the structures of the building during a period in which the occupants may be absent (during night time), reducing also the peak in the required power (Figure 2). In this way energy consumption may be reduced and lower night time electricity rate can be used. At the same time a reduction of the size of cooling system including chillier is possible

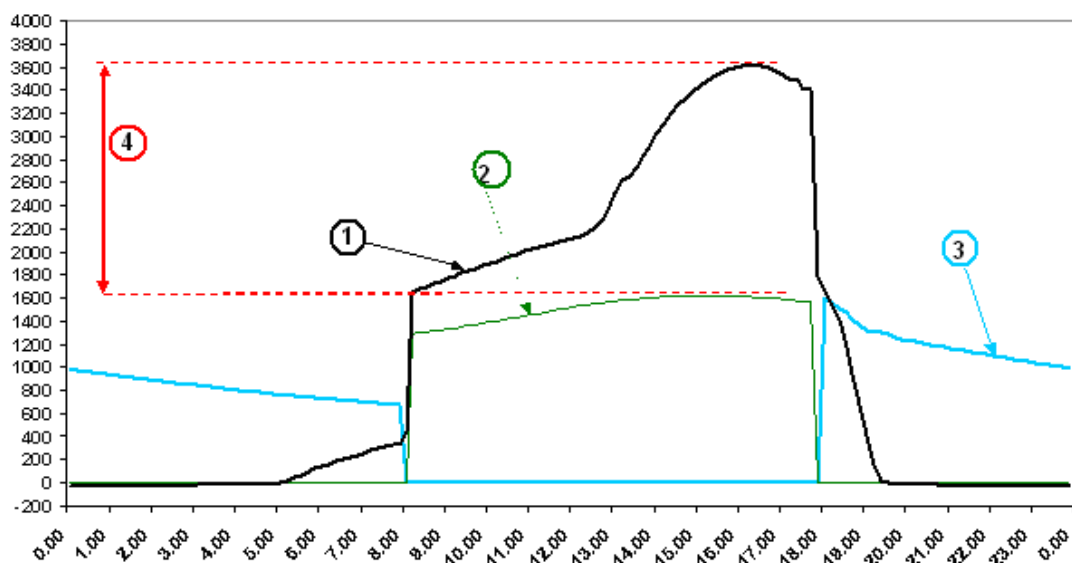

Figure 2 – Example of peak-shaving effect (X-axes: time; y-axes: cooling power W)
key: 1) heat gain, 2) power needed for conditioning the ventilation air,
3) power needed on the water side, 4) peak of the required power reduction

TABS may be used both with natural and mechanical ventilation (depending on weather conditions). Mechanical ventilation with dehumidifying may be required depending on external climate and indoor humidity production. In the example in Figure 2, the required cooling power needed for dehumidifying the air during day time is sufficient for cooling the slab during night time. The designer needs to know if the capacity at a given water temperature is sufficient to keep the room temperature in a given range. The designer needs also to know the heat flow on the water side to be able to dimension the heat distribution system and the chiller/boiler.

Some detailed building-systems calculation models have been developed, as for determination of the heat exchanges under non-steady state conditions in a single room, determination of thermal and hygrometric balance of the room air, prediction of comfort conditions, and check of condensation on surfaces, availability of control strategies and calculation of the incoming solar radiation. The use of such detailed calculation models is, however, limited due to the high amount of time needed for the simulations. Development of a more user friendly tool is required. Such a tool is provided in the present in EN15377-3, which allows simulation of thermo-active systems in an easy way.

Internal temperature changes only moderately during the day and the aim of a good design of TABS is to maintain comfort within the range of comfort, i.e. $-0.5 < PMV < 0.5$, during the day.

Steady state heating/cooling capacity can be calculated according to the method in EN15377-1.

The main advantages are the following :

- the thermal load is distributed in a longer period, which leads to lower peak loads, thus allowing to use conditioning plants of reduced sizes;
- the possibility to use two radiant surfaces leads to more uniform conditions in the conditioned space;
- the buildings have reduced dimensions with respect to the ones with suspended ceilings;

- it is possible to use conditioning plants suitable for temperatures close to room, i.e. heat pumps, condensation boilers, solar collectors, ground heat exchangers;
- for cooling purposes, the night over ventilation can be used as well;
- Low installation costs and low operation costs are possible.

The use of thermo-active systems on the other hand requires these aspects :

- active thermal slabs are used in multi-storey buildings with a central plant;
- attention has to be paid in the case of raised floors, while the ceiling surfaces have to be free from obstacles (no suspending ceilings can be used);
- the design of this type of radiant systems is very critical; adequate solar radiation screens, good thermal insulation of the envelopes, which has to be lower than $1 \text{ W}/(\text{m}^2 \text{ K})$, better $0.6 \text{ W}/(\text{m}^2 \text{ K})$, the transmitting insulation (shading elements)

TABS are installed in situ during the building construction or installed in pre-fabricated building elements. These systems have a high thermal inertia. Hence the accumulation and releasing of heat in the system can perform in different time. The system operates with reasonable low operation costs in the spaces where the structure of occupation allows temperature ramps during the day.

The diagram in Figure 3 show an example of the relation between internal heat gains, water supply temperature, heat transfer on the room side, hours of operation and heat transfer on the water side. The diagrams correspond to a concrete slab with raised floor ($R=0.45 \text{ m}^2\text{K}/\text{W}$) and a permissible room temperature range of $21 \text{ }^\circ\text{C}$ to $26 \text{ }^\circ\text{C}$.

The upper diagram shows on the y-axis the maximum permissible total heat gain in space (internal gains plus solar gains) W/m^2 , and on the x-axis the required water supply temperature. The lines in the diagram correspond to different hours of operation (8h, 12h, 16h, 24h) and different maximum amount of energy supplied per day $\text{Wh}/\text{m}^2 \text{ d}$.

The lower diagram shows the cooling power W/m^2 required on the water side (for dimensioning of chiller) for thermally activated slabs as a function of supply water temperature and operation time. Further, the amount of energy rejected per day is indicated $\text{Wh}/(\text{m}^2 \text{ d})$.

The example shows, that by a maximum internal heat gain of $38 \text{ W}/\text{m}^2$ and 8 hour operation, a supply water temperature of $18,2 \text{ }^\circ\text{C}$ is required. If, instead, the system is in operation for 12 hours, a supply water temperature of $19,3 \text{ }^\circ\text{C}$ is required. In total, the amount of energy rejected from the room is app. $335 \text{ Wh}/\text{m}^2$ per day. The required cooling power on the water side is by 8 hours operation $37 \text{ W}/\text{m}^2$ and by 12 hours operation only $25 \text{ W}/\text{m}^2$. Thus, by 12 hours operation, the chiller can be much smaller. The total heat rejection on the water side is app. $300 \text{ Wh}/\text{m}^2$ per day.

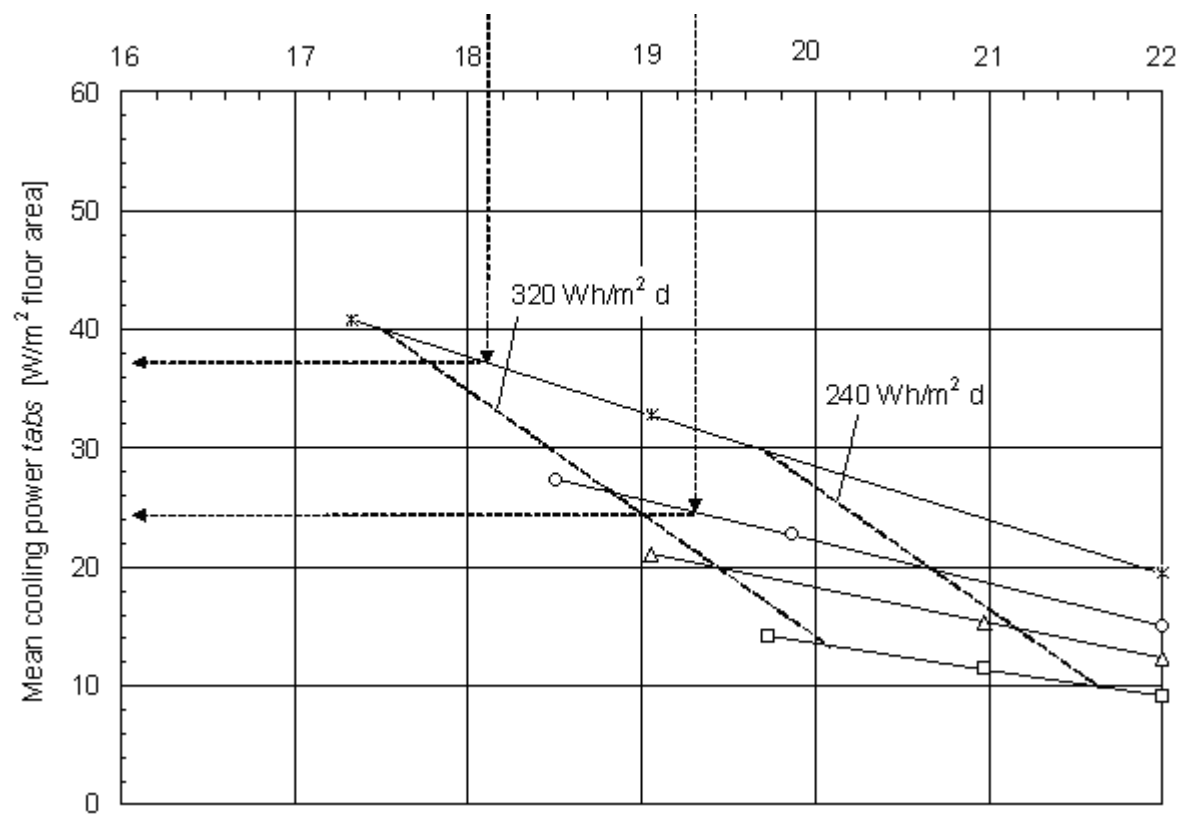
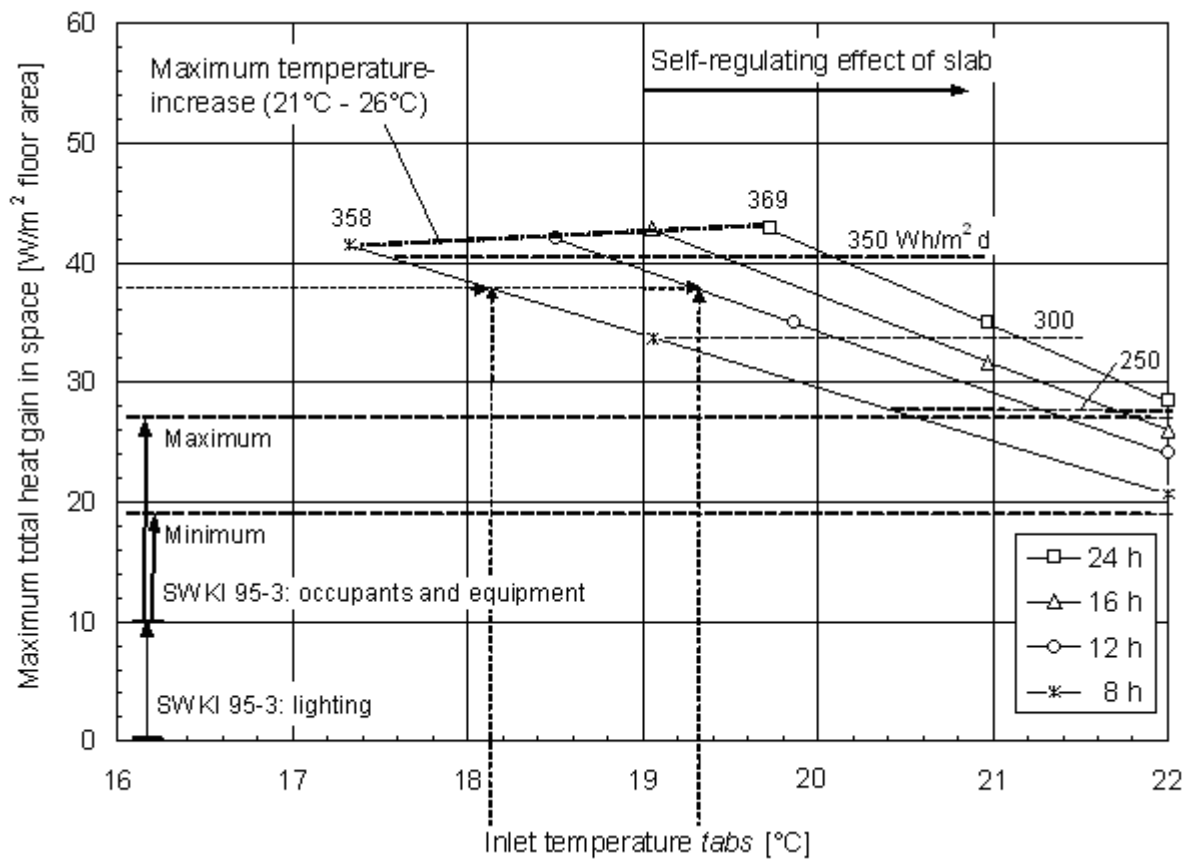

Figure 3 – Working principle of TABS

3.3.1 Impact on the indoor environment.

The room thermal comfort is maintained primarily by radiant heat transfer instead of convective heat transfer. An important factor for the thermal comfort of occupants is the mean radiant temperature. The minimum surface temperature depends on the dew point in the space

The uniform temperatures and surface temperatures close to room temperature will avoid any transportation of dust.

Because the systems are covered under the surface there is no risk for safety regarding people or machines getting in contact.

Due to the small temperature difference between the heated-cooled surface the systems have a high degree of self control and stable room temperatures is obtained.

3.3.2 Potential Energy Savings (qualitative)

Compared to full air systems the following potential energy savings exist:

5. Transportation of energy by water instead of air. Auxiliary energy for circulation pumps less than fans
6. For same comfort level (operative temperature) a higher air temperature in summer and a lower air temperature in winter are possible. That reduces the ventilation/infiltration losses
7. The system uses higher water temperature for cooling and lower water temperature for heating. This will increase energy performance of boilers (condensing boilers), heat pumps, chillers etc.
8. Due to the use of water temperature close to room temperature the potential for use of renewable energy sources are increased (free cooling,
9. Shift the loads to night time and operate using the cheaper night-tariff prices of electricity and more efficient use of free cooling
10. Reduction of peak load and system size, which will result in a higher efficiency of boiler, chillier and heat pump.

3.3.3 Potential Energy Savings (Quantitative)

To perform a yearly, dynamic computer simulation of such a system the heat transfer between surface and water in the pipes must be known. This can be found from the standard steady state calculation (EN15377-1) as an equivalent resistance between water temperature (average or supply). This equivalent resistance is then introduced into the building simulation. A critical factor in the dynamic calculation is the dynamic behavior of the systems. One method could be to include a specific heat capacity based of the material used. Finally to evaluate energy use on the waterside, it will be beneficial if the simulation program also can calculate the return water temperature, which will influence efficiency of boilers and chillers.

3.3.4 Energy Savings and Payback Calculation Assumptions

The cost of piping and mounting system will be in the range 20-30 € per square meter. In addition costs for supply and return water piping and installation costs. Maintenance cost is almost zero.

3.3.5 Simulation Results

The results of the simulations is included in a separate report

3.3.6 Environmental issues

In most cases the piping system is made of plastic resulting in a very low environmental emission during production. By demolition the pipes cannot be reused; but has a high embedded heating energy. The life time quality of the pipe can be estimated to 100 years.

3.3.7 Level of Maturity

More than 10 years

3.3.8 Climatic Conditions Necessary

The technology works equally well in any climate, however it is mainly a cooling technology which requires consideration of the dew point in the space. In hot-humid climates dehumidification must be applied.

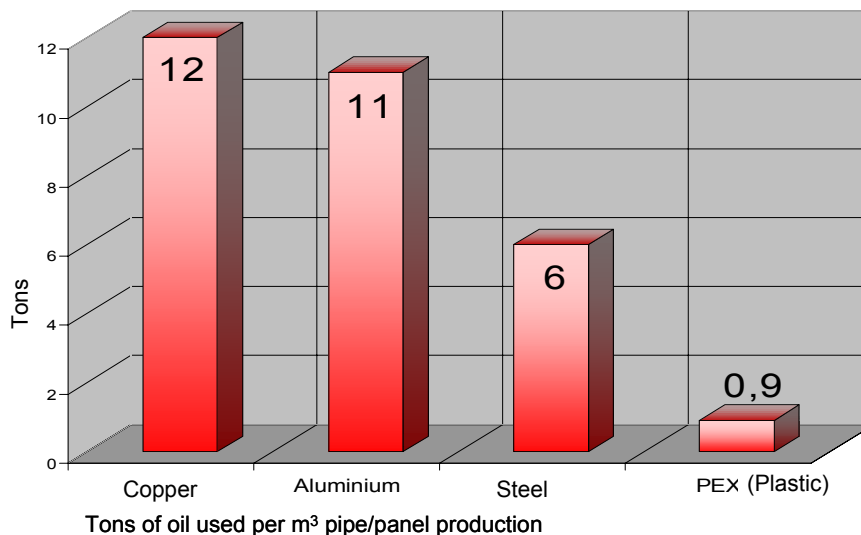

3.3.9 Contacts and Major Manufacturers

Main manufacturers are to be found in Europe (Zent-Frenger, UPONOR, ROTH, and Rehau). There also exist a European Association for surface heating and cooling systems (euray) and an American association (RAP)

3.4 Radiant heating and cooling panels.

Category:

HVAC and building

Application:

Residential, Industrial, Office Buildings, gymnasium halls etc

Description:

Radiant ceiling panels, are suspended under the ceiling with fluid temperature relative close to room temperature

Following panel heating and cooling systems are available on market:

- metal (copper, aluminium, steel) ceiling suspended panels (fin baseboard radiation)
- the case with pipes placed in a rill
- seamless integrated (copper/aluminium/gypsum) ceiling panel systems
- design islands / decorative ceilings

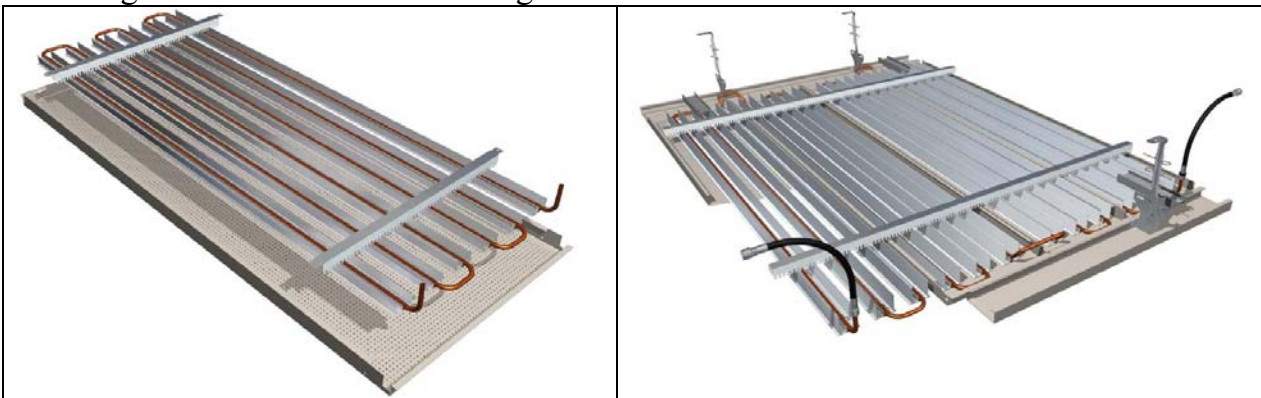

Figure 1 Construction of a cooling panel

The critical detail of a connection between the panel and the pipes significantly influences heat exchange between. If poor constructed the increase of temperature differences between the panel surface and the cooling fluid may occur. The arrangement of the water flow paths between two aluminium panels (for panels built in a “sandwich system”) reduces the heat transfer problem and increases the panel surface directly cooled. In the case of panels suspended below a concrete slab approx. 90% of the cooling power is available to cool/heat the room. The remaining 10% cools the floor of the room above (Fig 1 and 2)

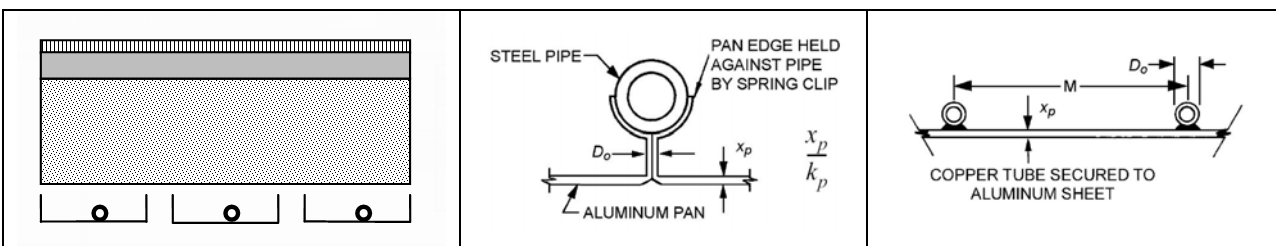

Figure 2 Ceiling panels structure; covering, floor, concrete slab, air space (or insulation), panels; construction of critical detail

The ASHRAE Handbook presents three different types of radiant systems:

- The first one is constituted by a metal sheet of about 300 mm by 600 mm with joint pipes with diameter between 15 and 20 mm. The distance between pipes can vary between 150 mm and 600 mm; the termination of pipes is connected to collectors of squared shape having side of 30-40 mm. The panel is upwards insulated (Figure 3).
- The second type is a metal panel of fixed dimensions 900 mm by 1500 mm, achieving a good thermal contact with the copper pipes (Figure 4).
- The third type is a joint disposition of extruded panels with a shape which allows inserting the pipes.

All these systems can work both in heating and in cooling conditions and have good performances. The space required is limited between 5 cm to 7 cm in thickness.

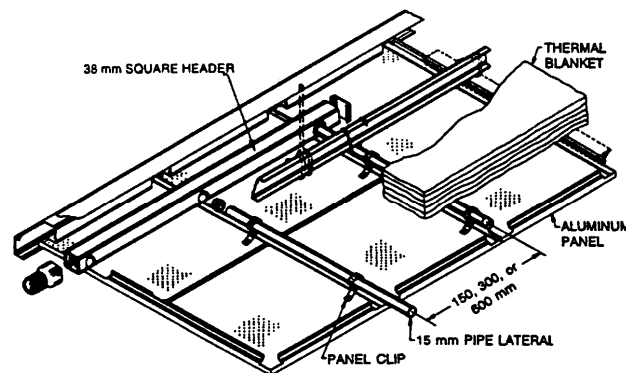

Figure 3 Light metal ceiling panels

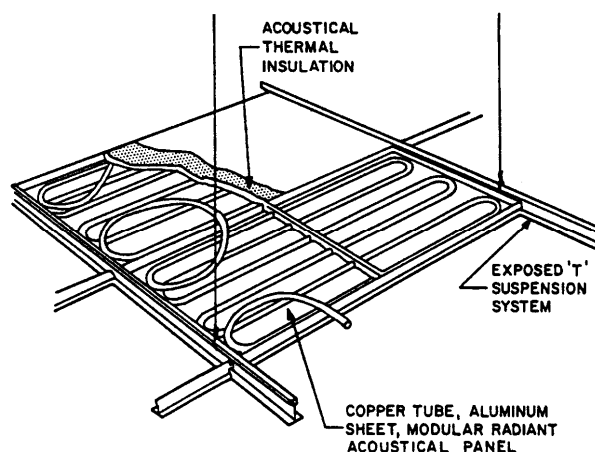

Figure 4 Light metal ceiling panel with copper pipes

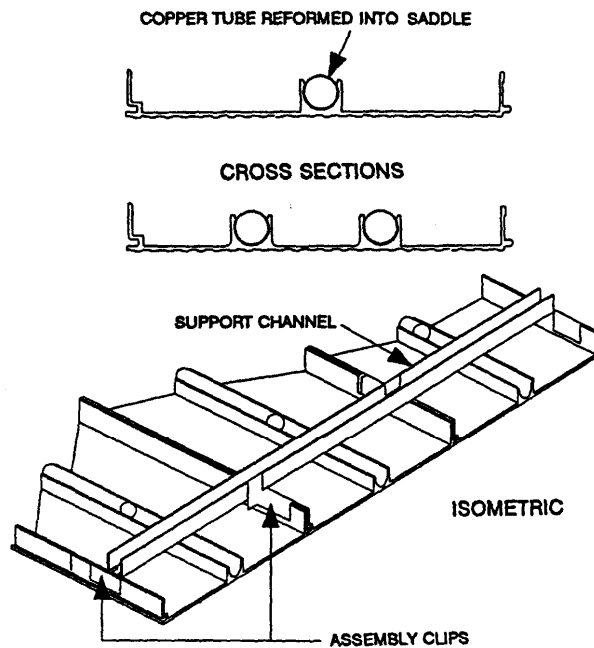

Figure 5 Ceiling extruded metal panels

Concept

Radiant panel ceiling systems are similar to other embedded systems with respect to the arrangement of its components. Thermal energy is exchanged between the room and people present in the space and the heated surface. Radiant cooling follows the same principles as radiant heating, but in reverse .

Radiant ceilings can be *installed after ceiling construction*. In this case the ceiling is already built and has some hangers in order to fix the pipes, which are usually made by steel or copper. The ceiling is composed by different layers: insulation, hangers, pipes, wire net, plaster. Moreover superposition of metal planes over the pipes is possible, in order to improve the performance of the radiant ceiling.

Ceiling heating and cooling panels are primarily used for large rooms such like one room offices storages halls and placed as panels suspended below a concrete slab or other horizontal building construction. Suspended, light radiant ceiling may cover the whole ceiling surface or can be used as a supplement to embedded system to allow for a fast changes in heating and cooling. The insulation over the panel is used to avoid the heat losses to the construction above. Most often used system is a cooling panel system, built from aluminium panels with metal tubes connected to the side of the panel facing away from the conditioned space (Fig 1).

The heating cooling capacity of the systems is made by testing according standard test methods.

EN 14037-2 Ceiling mounted radiant panels supplied with water at temperature below 120 °C - Part 2: Test method for thermal output

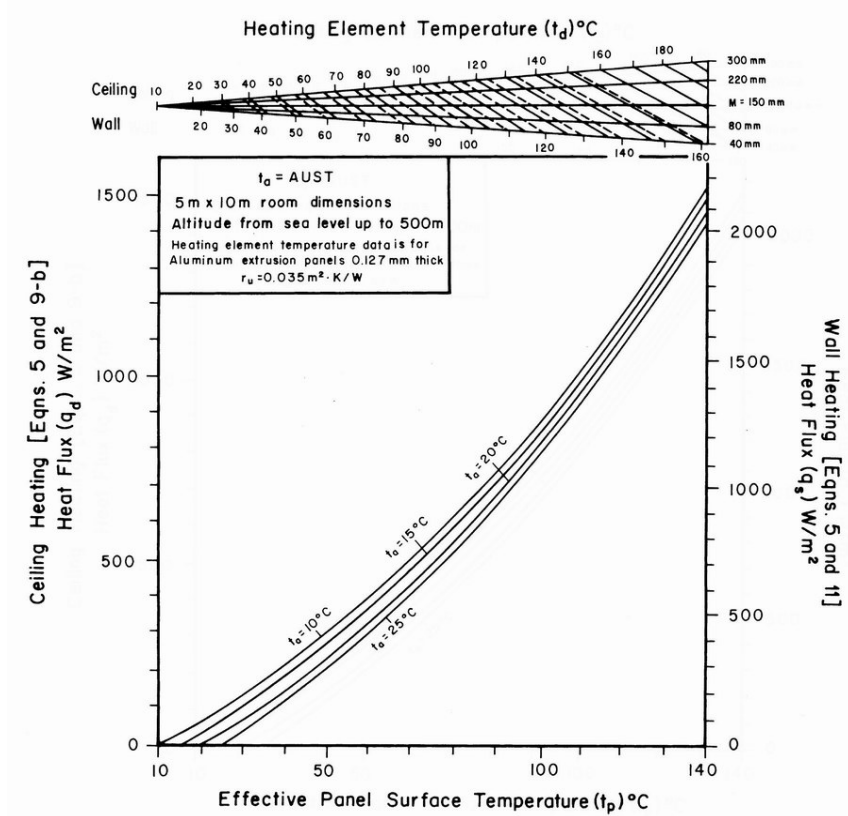

Figure 4.8 - Design graph for heating with aluminium ceilings and wall panels

3.4.1 Impact on the indoor environment.

The room thermal comfort is maintained primarily by radiant heat transfer instead of convective heat transfer. An important factor for the thermal comfort of occupants is the mean radiant temperature. The maximum surface temperature depends on the criteria for radiant asymmetry or direct contact with the surface.

The panel system may also include acoustical features, which will improve the acoustic in the space. Also the panels can be combined with an artificial lighting system.

3.4.2 Potential Energy Savings (qualitative)

Compared to full air systems the following potential energy savings exist:

11. Transportation of energy by water instead of air. Auxiliary energy for circulation pumps less than fans
12. For same comfort level (operative temperature) a higher air temperature in summer and a lower air temperature in winter are possible. That reduces the ventilation/infiltration losses
13. The system uses higher water temperature for cooling and lower water temperature for heating. This will increase energy performance of boilers (condensing boilers), heat pumps, chillers etc.

14. Due to the use of water temperature close to room temperature the potential for use of renewable energy sources are increased (free cooling,

3.4.3 Potential Energy Savings (Quantitative)

To perform a yearly, dynamic computer simulation of such a system the heat transfer between panel surface and water in the pipes must be known. This can be found from the standard test values as an equivalent resistance between water temperature (average or supply). This equivalent resistance is then introduced into the building simulation. A critical factor in the dynamic calculation is the dynamic behaviour of the panels. One method could be to include a specific heat capacity based on the material used. Finally to evaluate energy use on the waterside, it will be beneficial if the simulation program also can calculate the return water temperature, which will influence efficiency of boilers and chillers.

3.4.4 Energy Savings and Payback Calculation Assumptions

The cost of panels will be in the range 50-100 € per square meter. In addition costs for supply and return water piping and installation costs. Maintenance cost is relatively low.

3.4.5 Simulation Results

Results of the simulations are included in the separate report.

3.4.6 Environmental issues

As most of the components in the system is of metal the emission by production

Is relative high due to the amount of energy use in the production. After demolition the metals may be separated and reused.

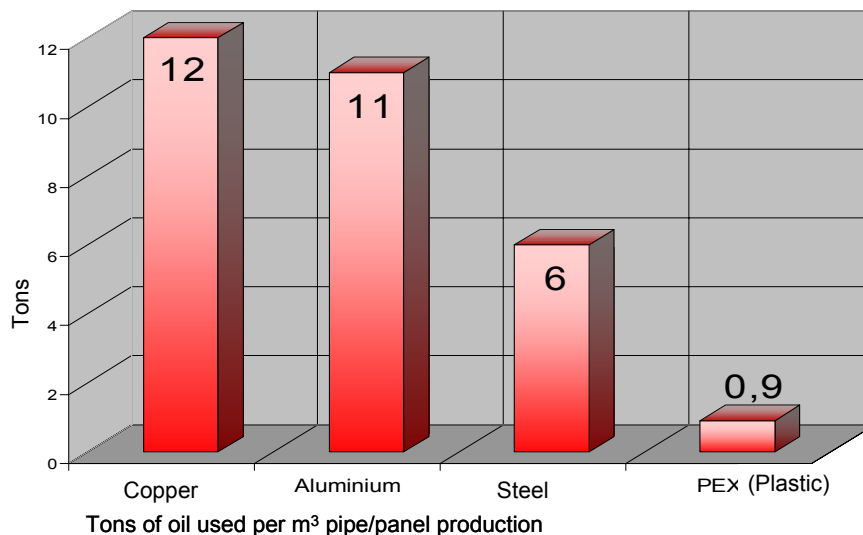

3.4.7 Level of Maturity

More than 30 years

3.4.8 Climatic Conditions Necessary

The technology works equally well in any climate, however it is mainly a cooling technology which requires consideration of the dew point in the space. In hot-humid climates dehumidification must be applied.

3.5 Envelope Sealing Systems: Radiant Barrier, and Spray Foam Insulation

Application: Industrial, Commercial, Institutional

Category: Building Envelope

Description: Envelope sealing technologies for large metal industrial type buildings fall into two categories

1. Spray foam sealants applied to the building interior
2. barrier systems also applied to the building interior

Spray foam sealants generally consist of a closed-cell polyurethane foam that is sprayed directly to the interior of the building steel cladding. The foam, which adheres to the building steel, is generally applied to a thickness of one inch or more. In addition to sealing against air infiltration, the foam provides an insulation value of approximately R-7 per inch. has to be explained for European people....

Barrier systems are typically applied inside the building to cover batt or board insulation. The systems range from the simple application of polyethylene sheeting to more sophisticated systems such as the radiant barrier system shown in the Figure below.

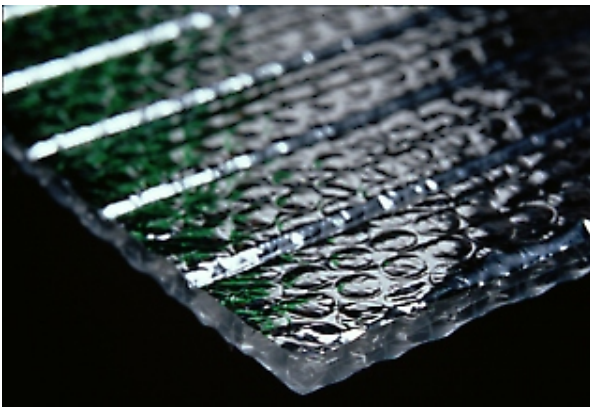

<http://www.ncfi.com/insulation.htm>



a. Radiant Barrier
(www.radiantbarrier.com)

b. Spray Foam
(www.fomof foam.com)

Concept:

Spray foam insulation systems eliminate both air infiltration paths and cold surfaces that moisture may condense on by direct application of a foam sealant/insulation to the metal skin of the industrial building. These systems provide three major benefits:

1. Reduced leakage through the building envelope.
2. Increased insulation of the building envelope.
3. Reduced condensation on interior surfaces

In Europe there are strict fire demands concerning these solutions. The foam has to be imbedded in a cavity.

What about cellulose should that be mentioned?

Barrier systems rely on sheets of air-tight material stretched over the interior of walls and roof to eliminate air infiltration. The sheets are usually applied over over a batt or board type insulation layer to form the interior surface of the wall or roof. The sheets must be overlapped and sealed (usually with caulk) at the edges as they are installed. Since barrier systems do not adhere to the building skin, any 'leaks' in the barrier, provide a potential path for warm air to reach cold surfaces with resulting condensation. Barrier systems must, therefore, be carefully installed and maintained. The radiant barrier system used in this comparative analysis provides three major benefits:

5. The low emissivity aluminum foil face significantly reduces radiant heat transfer to the space.
5. The 'air-bubble' core increases the insulation of the building envelope
5. The laminated construction resists punctures and tears.

3.5.1 Potential Energy Savings (Qualitative):

Reduction of air infiltration is the primary energy saving mechanism for both spray foam and barrier systems. Spray foam, with an insulating value of approximately R-7 per inch, can be applied to thicknesses that eliminate the need for additional insulation. Some barrier systems, such as the radiant barrier system described above, saves energy by reducing the thermal radiation exchange in the space and by providing some insulating value.

Existing insulation must be stripped from the walls prior to application of spray foam. The system is therefore better suited for uninsulated buildings. Barrier systems are designed to be installed over existing insulation.

3.5.2 Impact on Indoor Air Quality:

The system will reduce outside air infiltration. With a properly designed ventilation system, indoor air quality can be maintained.

3.5.3 Potential Energy Savings (Quantitative):

For the industrial building under consideration, approximately 600 ft. of exterior wall are potential candidates for envelope sealing. At a minimum, the window elevation which constitutes approximately 25% of the wall will be sealed. The leakage analysis was performed on a wind-driven flow pressure network with a balanced fan system using the perimeter cracks around the windows as a baseline for envelope leakage. This analysis results in 3000 sq. ft. of sealed envelope as shown in the table below. By assuming that the cracks between the steel sheeting is the same as the perimeter window cracks (not a bad assumption in many cases!), the analysis may be extrapolated to the entire building wall area without loss of generality.

The spray foam and radiant barrier system have approximately the same insulating value per inch. The radiant barrier system is approximately ¼” thick while spray foams are typically applied from 1-3 inches thick. Installed costs of the two technologies are shown in the table below. For one case 3 inches of spray foam insulation was applied. For the other case, a radiant barrier system was installed. The lower end of the cost range was selected for the comparison.

	Thermal Resistance	Infrared emittance	Installed Cost	Industrial building
3 inches of closed-cell polyurethane	R-7 per inch	0.92	\$2-\$3 per sq. ft. for three inch application	\$3600
Radiant barrier system	~R-7 per inch	0.15	\$1 - \$1.50 per sq. ft.	\$1800

3.5.4 Energy Savings and Payback Calculation Assumptions:

The effect of blown-in polyurethane was calculated by adding a three inch layer of insulation to the window level (15%) of the exterior walls. The insulation had a density of 1.561 ft³/lb_m (25 m³/kg), a conductivity of 0.012 BTU/hr-ft-°F (0.0206 W/m-K) and a specific heat of 0.239 BTU/lb_m-°F (1000 J/kg-K). The insulation also had the following radiation properties: thermal absorptance of 0.92, solar absorptance of 0.30 and visible absorptance of 0.30. In addition to adding additional insulation, the infiltration rates of all zones except for shipping were recalculated based on a flow network which assumed a balanced fan system and infiltration due to wind pressure on a leaky envelope. The analysis assumed that the total crack area was only the perimeter of the windows. For an unsealed sheet metal building, this is a conservative estimate. The analysis also assumed that sealing the envelope reduced the crack area by 50%.

The effect of the radiant barrier on infiltration was assumed to be identical to the spray foam. For the radiant barrier all exterior walls received a quarter inch of insulation. The insulation had a density of 1.561 ft³/lb_m (25 m³/kg), a conductivity of 0.012 BTU/hr-ft-°F (0.0206 W/m-K) and a specific heat of 0.239 BTU/lb_m-°F (1000 J/kg-K). The insulation also had the following radiation properties: thermal absorptance of 0.15, solar absorptance of 0.15 and visible absorptance of 0.15.

3.5.5 Climatic Conditions Necessary:

The technology is indicated only for cold climates and is effective only in reducing the heating load.

3.5.6 Energy Savings and Payback Calculation Results:

Sealing the envelopes around the windows resulted in very short payback periods in cold climates and in reasonable payback periods in all but the hottest climates as shown in the figures below. The payback period of the radiant barrier system was systematically lower than the spray foam system. This illustrates that the dominant effect is air infiltration, not envelope conduction. A thinner layer of foam insulation would have been more economical.

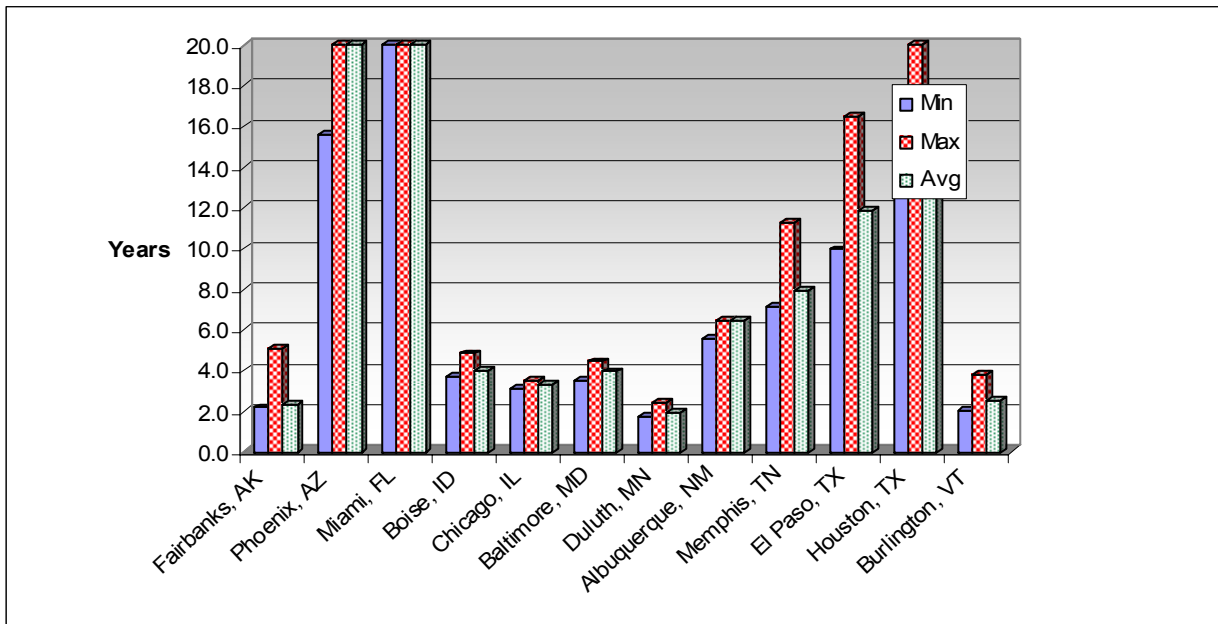

Radiant Barrier Estimated Payback for high, low and medium energy rates.

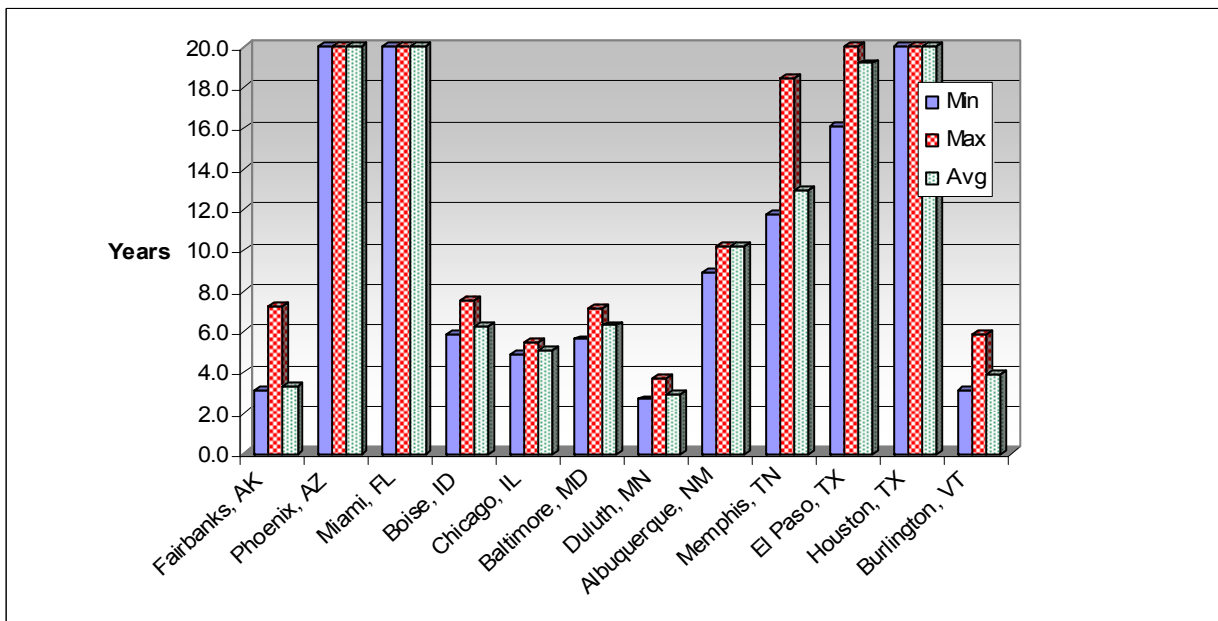

Spray Foam Estimated Payback for high, low and medium energy rates

The energy savings, show the added benefit of the spray foam insulation, which realizes greater energy savings across the board as shown in the following figures.

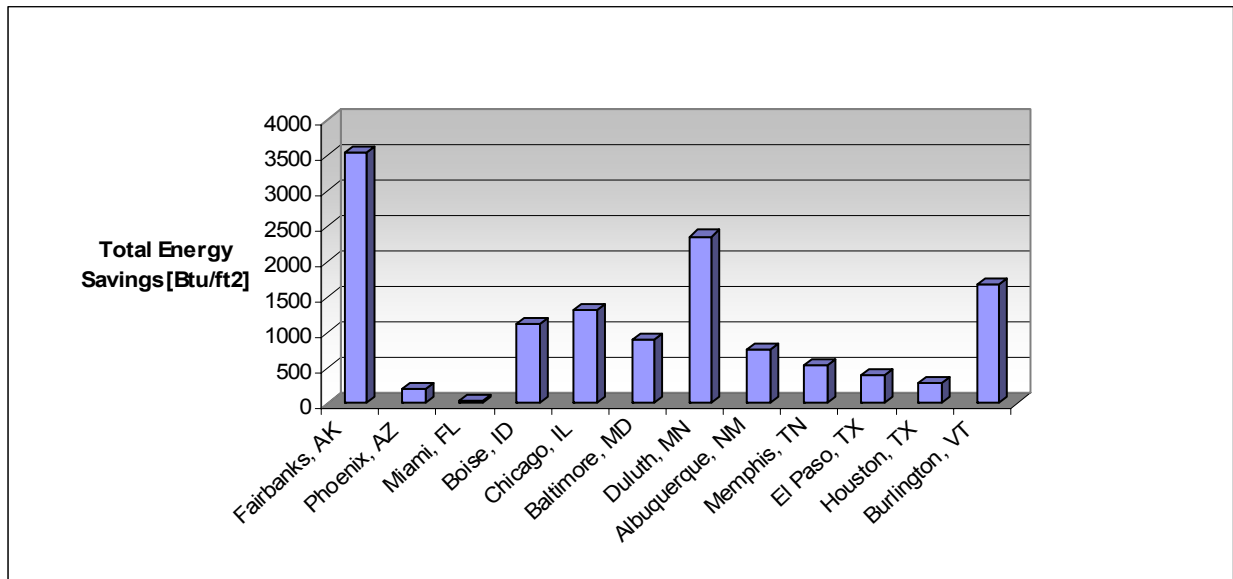

Radiant Barrier Total Energy Savings

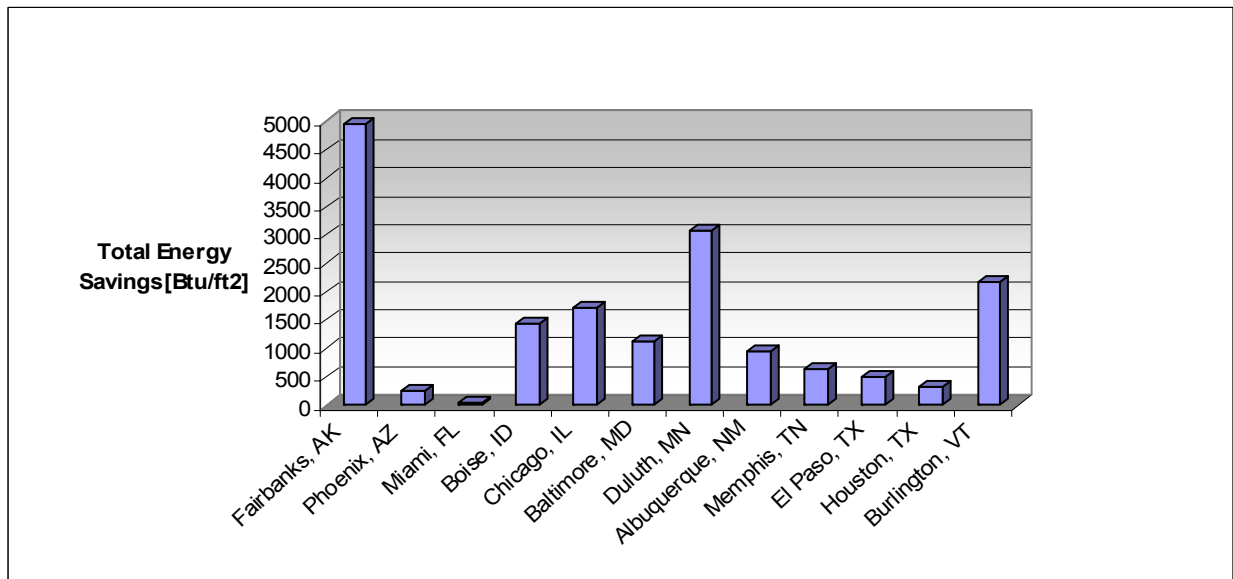

Spray Foam Insulation Total Energy Savings

The energy savings are entirely due the gas savings as shown in the following figures. For this building, the effect on electrical energy consumption (fan power) was essentially zero.

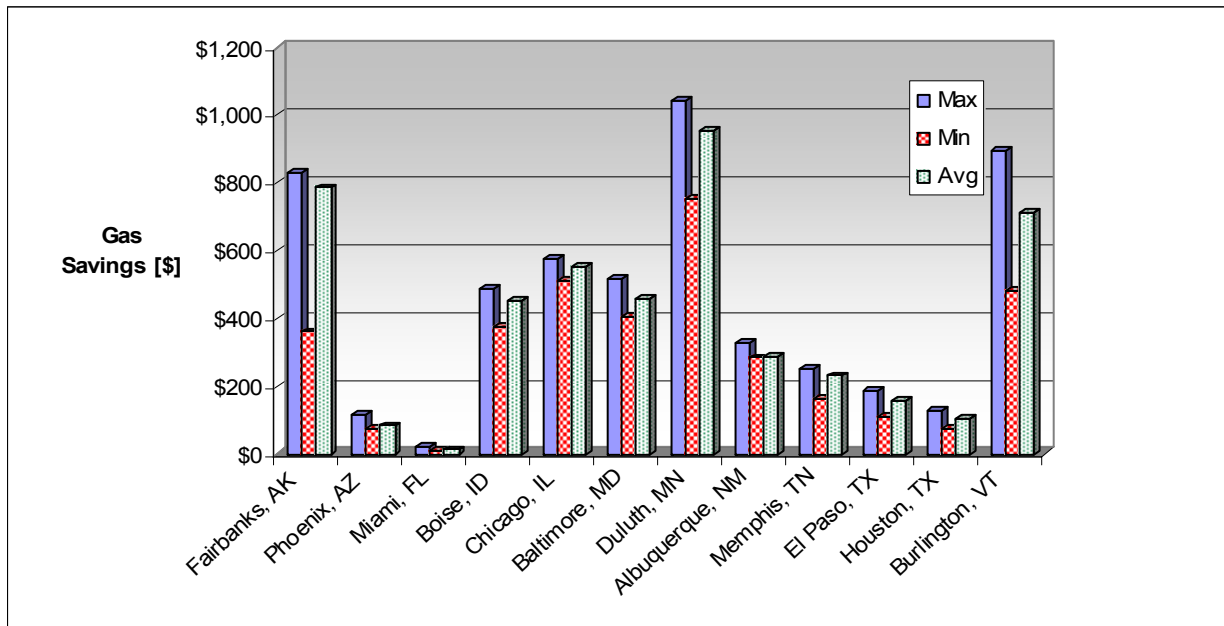

Radiant Barrier Gas Savings

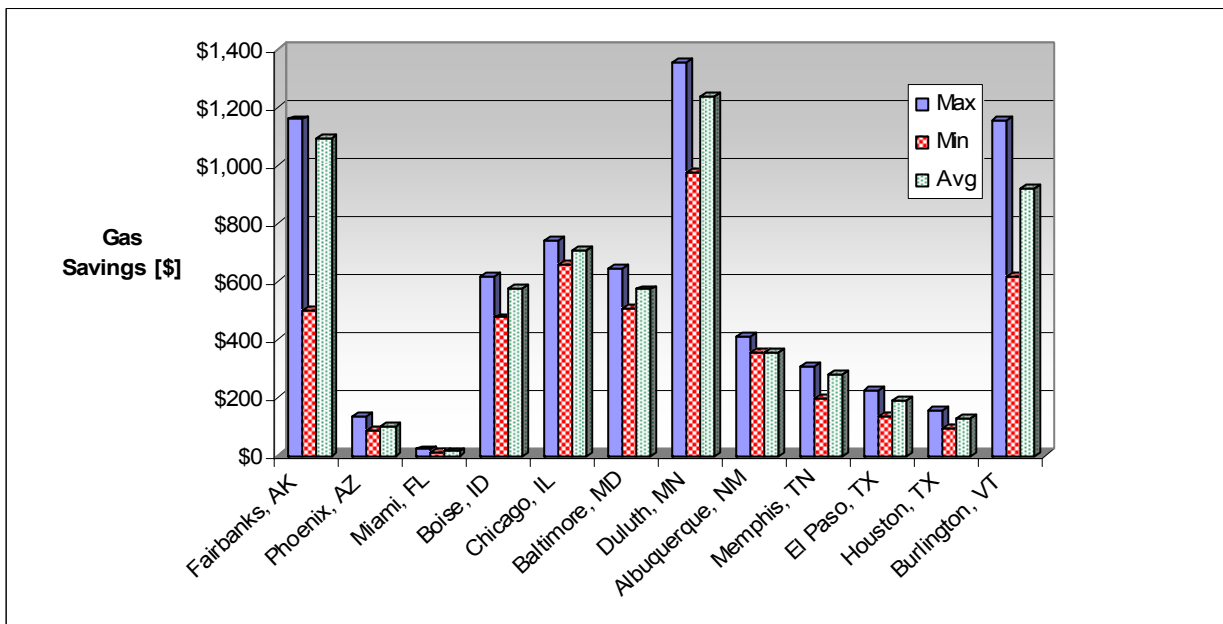

Spray Foam Gas Savings

3.5.7 Practical Experience:

Contractors indicate that the radiant barrier system is more comfortable in the summer months and less comfortable in the winter months. This is likely due to solar heating of the building envelope, which will result in improved comfort for low emissivity surfaces in the summer months. In the winter months, warming of the building will have less of an effect on occupant comfort for the same reason

3.5.8 Level of Maturity:

5-20 years

3.5.9 Major Manufacturers:

Spray foam:

Icynene Inc.
Address: 6747 Campobello Road
City, state: Mississauga, Ontario
Zip/postal code: L5N 2L7
Country: Canada
Phone: (905) 363-4040
Toll free phone: (800) 758-7325

DEMILEC, Inc.
870 Cure Boivin
Boisbriand (Quebec)
J7G 2A7
CANADA
Phone: (450) 437-0123

Radiant barrier:

Innovative Insulation, Inc.
6200 W. Pioneer Parkway
Arlington, TX 76013
Toll free phone: (800) 825-0123

4 Referencer

1. Website of IEA ECBCS Annex 46: Holistic Assesment Tool-Kit on Energy Efficient Retrofit Measures for Government Buildings (EnERGo)Annexes - <http://www.annex46.org/>
2. Danish participants of IEA ECBCS Annex 46: <http://www.annex46.org/participants/denmark/>

5 Annexes

5.1 Template format for ECM descriptions

Technology/Energy Conservation Measure (ECM) Description Template format

3-4 pages with pictures, schematics and references.

Category: (Building envelope, Process, Internal load, HVAC and other systems, lighting), Application: (e.g., Industrial or Office Buildings)

Title/ECM name

1. Short technology/measure description, overview of different types available
2. Generic illustrations/schematics/pictures
3. Which technologies/measures can be replaced/improved
 - a. Energy saving/process improvement concept
4. Potential Energy Savings (per unit of building area, manufactured product, related to other relevant units)
5. Impact on the indoor environment: air quality, lighting quality etc.
6. Technology costs, installed costs, itemized LCC/payback (life cycle costs) -. maintenance cost, repair costs
7. Environmental issues, reuse, lifetime, etc..
8. Assumptions (for energy saving and payback): Major relevant characteristic features and their quantitative parameters, critical physical parameters.
9. Results
10. Experiences/Lessons learned
 - a. Practical experiences of interest to a broader audience,
 - b. Pros. and cons., when compared with other technologies/measures, e.g. level of Maturity
11. Major manufacturers
12. References

5.2 Case study format

Energy Conservation in Government Buildings Case Study Description Template (Developed through discussions at the ASHRAE TC 7.6 Working Group meetings)

Case Study template format: 4-6 pages with pictures, schematics, POC information, and references.

Case Study #

Title: A retrofit for Energy Conservation using.....

Name of the building, location:

1. Photo of the building
13. Project summary
14. Site
15. Building description
 - a. Type/age
 - b. General
 - c. Architectural drawing
 - d. Process description
 - e. Previous heating, ventilation, AC, lighting systems
16. Description of the problem
17. Solution
 - a. Retrofit energy technology features
 - i. Energy saving/process improvement concept
 - ii. Building improvement
 - iii. New HVAC system
18. Resulting Energy Saving
19. Renovation Costs
20. User evaluation
21. Experiences/Lessons learned
 - a. Energy use
 - b. Impact on indoor air quality
 - c. Economics
 - d. Practical experiences of interest to a broader audience
 - e. Resulting design guidance
22. General data
 - a. Address of the project
 - b. POC information
 - c. Date of the report
23. Acknowledgement
24. References

Please, e-mail this information to Alexander.M.Zhivov@erdc.usace.army.mil

Questions? Please, call 217 352 6511, ext. 7461 – Alexander Zhivov, or 217-373-7278 – Dale Herron.